

# Product Manual

**NONEL<sup>®</sup> and PRIMACORD<sup>®</sup>**

**DYNO**  
Dyno Nobel

**G r o u n d b r e a k i n g   P e r f o r m a n c e**

## **Disclaimer & Trademarks**

---

### **General Disclaimer**

Dyno Nobel has endeavored to make the information in this Manual accurate and educational, but makes no guarantee or warranty of the accuracy or completeness of the matters addressed herein. This information is intended as a reference source only. Any third parties and their employees who receive and use this information agree to assume all risk, liability and/or responsibility whatsoever from any and all fines, damages or injuries to persons or property arising from the use of this information or reliance upon any of the materials or information presented herein.

### **Product Disclaimer**

Dyno Nobel Inc. and its subsidiaries disclaim any warranties with respect to these products, the safety or suitability thereof, or the results to be obtained, whether express or implied, INCLUDING WITHOUT LIMITATION, ANY IMPLIED WARRANTY OF MERCHANTABILITY OR FITNESS FOR A PARTICULAR PURPOSE AND/OR OTHER WARRANTY. Buyers and users assume all risk, responsibility and liability whatsoever from any and all injuries (including death), losses, or damages to persons or property arising from the use of this product. Under no circumstances shall either Dyno Nobel Inc. or any of its subsidiaries be liable for special, consequential or incidental damages or for anticipated loss of profits.

### **Trademarks**

The following names, phrases and logos are trademarks of Dyno Nobel Inc. (or its affiliates) in the United States and certain foreign countries:

NONEL®	Primacord®	Primaline®
EZ DET®	EZ Drifter®	Primashear®
EZTL™	Low Flex™	The Dyno Nobel logo
Groundbreaking Performance™		Dyno®

Issued: March 2011 (Rev. 1)

© 2007, 2005, 2011 Dyno Nobel Inc.

**DYNO**®  
Dyno Nobel

**Groundbreaking Performance™**

# The IPL Values we all live by every day



**OwnBreakoutDeliver**





Treat the business as our own

- ▶ Achieve the best financial outcomes through controlling costs, minimising waste and protecting our assets
- ▶ Develop positive customer and supplier relationships that benefit and grow the business
- ▶ Be accountable and act with honesty and integrity
- ▶ Invest in initiatives that secure our future



Value People - Respect, Recognise & Reward

- ▶ Respect each other and work as a team
- ▶ Communicate in an open and honest manner
- ▶ Invest in the development of people through training and mentoring
- ▶ Recognise and reward in line with performance
- ▶ Work together to achieve a work-life balance



Zero Harm for Everyone Everywhere

- ▶ Promote safe behaviours > Think safe > Act safe > Be safe
- ▶ Train and follow safety systems and procedures
- ▶ Identify and control hazards
- ▶ Look after ourselves and each other



Care for the Community & our Environment

- ▶ Listen to and work with the community
- ▶ Treat water as a precious resource
- ▶ Minimise environmental impacts and leave NO legacies



Think Customer. Everyone. Everyday.

- ▶ Listen, understand and exceed customer expectations
- ▶ Build enduring and mutually beneficial customer relationships at all organisation levels
- ▶ Deliver safe, reliable products and services on time and complete
- ▶ Be the easiest company to do business with



Challenge & Improve the Status Quo

- ▶ Be proactive in seeking continuous improvement of ideas
- ▶ Embrace change and pursue innovative solutions



Deliver on our Promises

- ▶ Do what we say we're going to do
- ▶ Take ownership
- ▶ Find creative ways to deliver
- ▶ Clearly communicate



# Table of Contents

<b>Disclaimer &amp; Trademarks</b> .....	<b>i</b>
General Disclaimer .....	<b>i</b>
Product Disclaimer .....	<b>i</b>
Trademarks.....	<b>i</b>
<b>Major Explosives Innovations</b> .....	<b>1</b>
<b>Shock Tube</b> .....	<b>2</b>
<b>NONEL® Detonators</b> .....	<b>3</b>
<b>NONEL® Product Line</b> .....	<b>5</b>
<b>General Warnings</b> .....	<b>8</b>
<b>Connectors and Connections</b> .....	<b>10</b>
<b>EZ Connector™ Blocks</b> .....	<b>10</b>
<b>Bunch Block</b> .....	<b>11</b>
<i>With Shock Tube</i> .....	<b>11</b>
<i>With Detonating Cord</i> .....	<b>12</b>
<b>NONEL® nonelectric delay detonators</b> .....	<b>13</b>
<b>NONEL EZ DET®</b> .....	<b>13</b>
<i>Loading Procedures</i> .....	<b>13</b>
<i>Use in Surface Hook-up</i> .....	<b>13</b>
<i>Connection Inspection</i> .....	<b>14</b>
<i>Special Applications - Trench Blasting</i> .....	<b>15</b>
<b>NONEL EZ DRIFTER®</b> .....	<b>16</b>
<i>Shot Hook-up</i> .....	<b>16</b>
<b>NONEL EZTL™</b> .....	<b>17</b>
<i>As a Surface Delay for the EZ DET System</i> .....	<b>17</b>
<i>As a Surface Delay for MS or LP Detonators</i> .....	<b>18</b>
<i>Connection Inspection</i> .....	<b>18</b>
<b>NONEL Lead Line</b> .....	<b>19</b>
<b>NONEL LP</b> .....	<b>21</b>
<i>Loading with Cartridged High Explosives</i> .....	<b>21</b>
<i>Connecting Shock Tube to Detonating Cord Using J-Hooks</i> .....	<b>22</b>
<b>NONEL MS</b> .....	<b>23</b>
<i>Hook-up of MS Detonators with TDs</i> .....	<b>24</b>
<b>NONEL MS Connector</b> .....	<b>25</b>
<i>Use as a Surface Delay with Detonating Cord</i> .....	<b>25</b>
<i>Use as a Surface Delay with PRIMACORD 2 (10 gr/ft)</i> .....	<b>26</b>
<b>NONEL SL</b> .....	<b>27</b>
<i>Loading Procedures</i> .....	<b>27</b>
<i>Making NONEL SL/Sliding Delay Primer Assembly</i> .....	<b>29</b>
<b>NONEL TD</b> .....	<b>30</b>

Use with Shock Tube .....	30
Use with Detonating Cord .....	30
Separate Charge Firing - Same Delay Each Hole .....	32
<b>PRIMALINE® SMS.....</b>	<b>33</b>
Loading Procedures.....	33
Hook-up to Trunklines .....	34
<b>NONEL General Application Instructions.....</b>	<b>35</b>
Primer Assemblies .....	35
Walking the Shot.....	35
Initiating the Shot .....	36
<b>Detonating Cord Product Line .....</b>	<b>38</b>
Trunkline.....	39
Downline.....	40
Trunklines/Downlines.....	40
<b>Connections &amp; Knots .....</b>	<b>41</b>
Detonating Cord to Cord Connections .....	41
Knots.....	41
Detonating Cord to Shock Tube Connections .....	42
J-Hooks.....	42
Bunch Blasting .....	43
<b>PRIMACORD &amp; PRIMALINE .....</b>	<b>44</b>
Priming .....	44
Cast and Slurry Boosters .....	44
Loading Holes .....	44
Cutting Detonating Cord .....	45
Proper Number of Downlines.....	45
Connecting the Blastholes .....	46
Instant Firing with PRIMACORD and PRIMALINE Trunklines .....	47
Delay Firing With PRIMACORD and PRIMALINE Trunklines .....	47
Initiation of PRIMACORD and PRIMALINE .....	50
To Attach Detonator .....	50
Initiation of Wet Detonating Cord .....	51
Using PRIMACORD & PRIMALINE with Bulk Explosives .....	52
<b>Product Troubleshooting.....</b>	<b>53</b>
NONEL EZ DET - Shot Initiation .....	54
<b>Connection Inspection.....</b>	<b>55</b>
NONEL EZ DET & EZTL - Connection.....	56
NONEL EZ DET & EZTL - Connection.....	57
NONEL EZ DET & EZTL - Connection.....	58
NONEL EZ DET & EZTL - Matting.....	59
NONEL EZ DET & EZTL - Matting.....	60

Connector Block Confinement.....	61
NONEL TD - <i>Connection</i> .....	62
NONEL TD - <i>Connection</i> .....	63
NONEL TD, LP and MS - <i>Shock Tube to Detonating Cord</i> .....	64
NONEL TD, LP and MS - <i>J-Hook: Shock Tube to Detonating Cord</i> .....	65
NONEL TD, LP and MS - <i>J-Hook: Shock Tube to Detonating Cord</i> .....	66
NONEL SL - <i>Knot Connection</i> .....	67
NONEL SL - <i>Knot Connection</i> .....	68
NONEL MS Connector - <i>Connection</i> .....	69
NONEL MS Connector - <i>Cord Not in Groove</i> .....	70
NONEL MS Connector - <i>Detonating Cord Tail Damage</i> .....	71
Detonating Cord Cut-off.....	72
Shock Tube Abrasion .....	73
Pinch-Smash Breaks .....	74
Pinch-Smash Breaks - <i>Lower, Don't Drop</i> .....	75
Reverse Propagation Testing .....	76
Detonating Cord - <i>Connection Inspection</i> .....	77
Check Tubes - <i>Connection Inspection</i> .....	78
Lead Line - <i>Powder Migration Prevention</i> .....	79





## Major Explosives Innovations

### All Part of the New Dyno Nobel

1831

**Safety Fuse** is invented by William Bickford, the fore-runner of The Ensign-Bickford Company, to replace pure black powder-filled cord (mining safety increases dramatically).

Alfred Nobel, the founder of companies that laid the foundation of Dyno Nobel, invents the first **blasting cap**.

1865

1867

Alfred Nobel invents **dynamite**, another major step in explosives safety and efficiency.

A reliable, flexible, easy-to-use **textile-jacketed detonating cord -- Primacord®** -- is developed by The Ensign-Bickford Company.

1936

1956

**Slurry explosives** are pioneered by Dr. Melvin Cook (IRECO, later Dyno Nobel).

Dyno Nobel develops revolutionary inert-until-mixed **site-mixed (SMS™) pump truck systems** for slurry explosives, as well as small diameter packaged products.

1960s

1967

Nonelectric initiation system, **NONEL®**, invented by Per Anders Persson (Nitro Nobel, later Dyno Nobel); introduced to market in 1972.

Dyno Nobel commercializes **packaged and bulk emulsions**, another type of water-based explosive.

1980s

1980s

Continuing development of **nonelectric initiation systems** by both The Ensign-Bickford Company and Dyno Nobel. Continuing development of sophisticated **bulk delivery systems** by Dyno Nobel.

1990s

DynoConsult, a **specialist consulting** division of Dyno Nobel, is formed.

1999

2003

Dyno Nobel continues to **lead the explosives industry** by combining Dyno Nobel and The Ensign-Bickford Company.

## Shock Tube

---

Shock tube is a small diameter (3mm outer diameter) laminated plastic tube internally coated with approximately 14.86 grams of reactive material per kilometer (1 pound per 100,000 feet). This tube transmits a low energy signal from the point of initiation to the delay cap at approximately 2,100 m/s (6,500 f/s). This shock wave phenomenon, which is similar to a dust explosion, will propagate through most sharp bends, knots and kinks in the tube. The detonation is sustained by such a small quantity of reactive material that the outer surface of the tube remains intact during and after functioning.

The tube is extruded in multiple layers, generally three (3), each of which has different properties. The innermost layer has good adhesive properties for the reactive material to adhere. The middle layer gives the tube its good tensile strength and the radial strength that is necessary to prevent the tube from bursting by the strain caused when the shock wave goes through it. The outermost layer has good abrasive resistance and is also the layer where the coloring of the tube is done. The tube is UV-protected to withstand strong sunlight during extended exposure without the ability to initiate being affected.

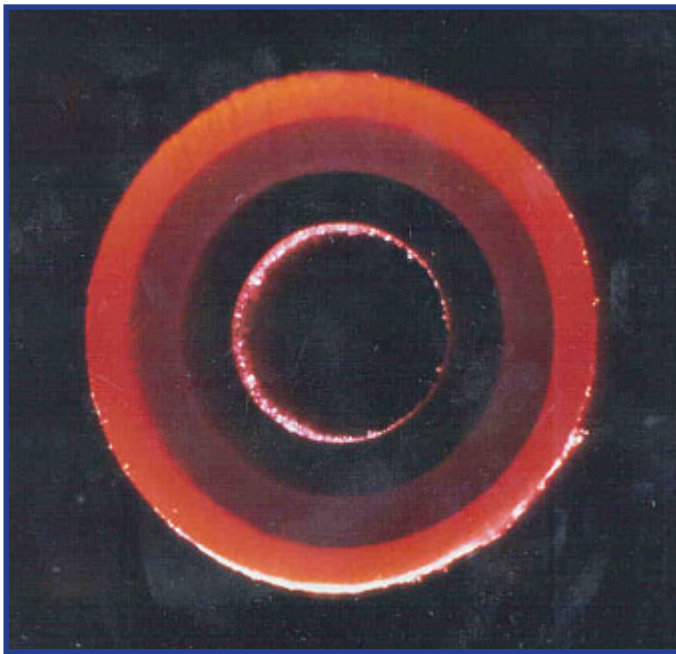

*Figure 1 - Cross-section of NONEL shock tube.*

## NONEL® Detonators

Dyno Nobel's patented NONEL® nonelectric delay detonator technology provides the most reliable nonelectric detonator on the market. NONEL detonators are designed from the top down to prevent external contamination of the components, and ensure precise, reliable initiation. Aside from the cap shell, the only visible component is the rubber bushing, which (in concert with the flatland crimp) effectively seals out any external contamination, making the detonator water resistant.

Dyno Nobel detonators are designed using patented technology featuring components that:

- control signal transmission, ensuring reliable signal pick-up and helping prevent any timing or functionality problems associated with depressurization of the NONEL assembly.
- clean traces of explosives from the sides of the shell to help prevent instantaneous detonation, as well as aiding the resistance of "reverse propagation" and increasing impact resistance.
- provide a controlled discharge path for any static build-up in the tube, as well as centralizing alignment of the tube to ensure good transfer of the initiation signal to the elements below.

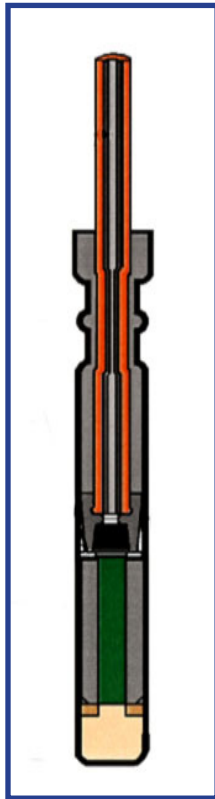

Figure 3 - Surface detonator.

Downhole detonators (Figure 2) employ both a primary charge and a base charge to provide the strength necessary to detonate modern explosives. Lead Azide is the primary charge; its shape allows it to be fully encapsulated by the base charge, which generally consists of PETN or polycoated PETN. Surface detonators (Figure 3), which do not require as much strength, utilize a simple Lead Azide explosive charge.

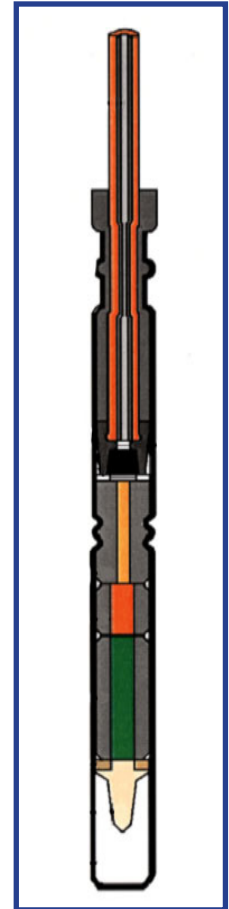

Figure 2 - Down-hole detonator.

During the last 50 years, research has been concentrated on better precision timing of the detonator. Nevertheless, there is an unavoidable scatter in timing between different detonators with the same nominal time. The scatter depends

on small differences in raw material, packing density of the pyrotechnic composition and temperature, along with the age of the detonator.

With short delay times in the MS series (0.025 sec) the margins are small to avoid overlapping. Overlapping occurs if a detonator with higher period number detonates before one with a lower period number. Many countries have their own regulations regarding cap scatter; however, Dyno Nobel has internally set the scatter limits on its detonators tighter to avoid the risk of overlapping.

## **NONEL<sup>®</sup> Product Line**

---

The NONEL<sup>®</sup> nonelectric delay detonator family consists of the following products:

### **EZ DET<sup>®</sup> nonelectric blast initiation system**



The EZ DET system is suited for use in construction, surface and underground blasting. It eliminates the need to inventory various in-hole delays and provides fast, simple hook-up while allowing an unlimited number of holes to be shot with independent hole initiation. Each unit consists of a precise in-hole delay detonator and a surface delay detonator housed in a plastic EZ Connector™

block, linked by a length of shock tube. They are available in various lengths and delay times.

### **EZTL™ trunkline delay detonators**

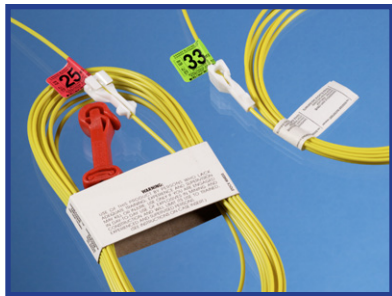

EZTL are precise, reliable millisecond delays, with delay times and hardware suited for use as trunklines in open pit mining, quarrying, construction and underground mining. They consist of a surface delay detonator housed in a plastic EZ Connector™ block, attached to a length of shock tube. EZTL are available in various lengths and delay times.

### **EZ DRIFTER<sup>®</sup> nonelectric blast initiation system**



The EZ DRIFTER system is used extensively in underground mining. An EZ DRIFTER unit consists of a precise, high strength in-hole delay detonator and a surface delay detonator housed in a plastic EZ Connector™ block, linked by a length of shock tube. They are available in various lengths and a delay time of 200/5400.

## LP

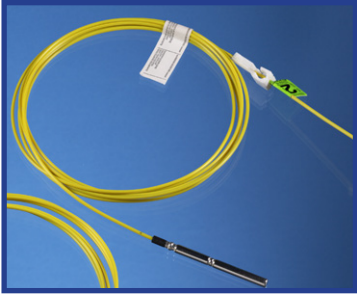

LP detonators are precise in-hole delay detonators used extensively in underground mining, tunneling, shaft sinking and special construction applications. The LP series consists of a high strength detonator crimped to a length of shock tube. LP units are available in various lengths, and delay times ranging from 0 to 8000 milliseconds.

## MS



MS detonators consist of a precise, millisecond delay detonator crimped to a length of shock tube, and are used in open pit mining, quarrying, construction and underground mining. MS units are available in various lengths, and delay times ranging from 0 to 1000 milliseconds.

## MSConnector

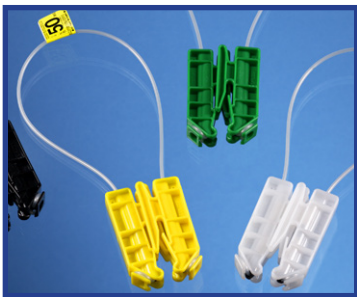

MSConnectors consist of an 18 inch length of shock tube with detonators of the same delay, inside connector blocks, on each end. MSConnectors are used to provide millisecond delay timing between holes of detonating cord initiated blasts. They are available in delay times ranging from 9 to 200 milliseconds.

## TD

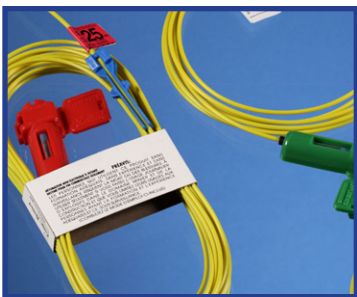

TD units provide precise, reliable surface delay times, lengths and hardware suited for initiating detonating cord or shock tube downlines in various surface applications. They consist of a precise surface delay detonator housed in a plastic Bunch Block, crimped to a length of shock tube. TD units are available in various lengths and delay times ranging from 5 to 200 milliseconds.

## SL



SL detonators are 76 cm (30 in) lengths of shock tube with a precise in-hole delay detonator on one end, and a loop of shock tube on the other. SL units are designed to be used in conjunction with low-energy detonating cord downlines. When used in a slider configuration they provide independent deck initiation from a single downline. The SL series consists of delay periods ranging from 0 to 1000 milliseconds.

## Starter and Lead Line



Starter is used as the primary initiator of mining, quarrying and construction blasts. It consists of a spool of shock tube with a precise surface delay detonator crimped to one end, housed in a plastic Bunch Block. Starter is available in lengths of 200, 500 and 1000 feet. Lead Line consists of a 2500 foot spool of shock tube.

## Primaline® SMS

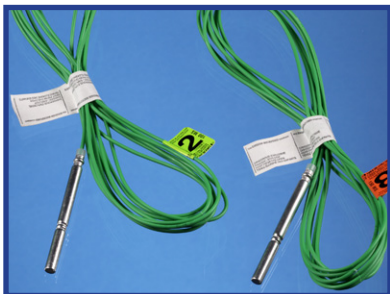

SMS units consist of a precise nonelectric detonator on a 4 grain/foot Primaline® detonating cord lead. Because of the self-consuming nature of the Primaline detonating cord, it is ideally suited for mining situations where ore contamination cannot be tolerated, such as salt and chemical limestone mines.



## General Warnings

---

# ALWAYS

... guard, barricade, and post or flag holes waiting to be fired against unauthorized entry.

... protect the explosives from unintended energy. Explosives have to be sensitive to purposefully supplied energy when you want to initiate them. This sensitivity means they can be initiated when energy is accidentally supplied. Some examples of sources of unintended initiating energy that users must guard against are: the impact of a falling rock on a cap; abrasion or impact by drilling into a misfired cap that has not been recovered and disposed of in accordance with sound practice; the impact of a tracked vehicle or other equipment on an exposed cap; flame or fire, lightning or other electric discharge such as contact by electric wires.

... select and use the NONEL length, delay series and system that is appropriate for your conditions and intended use.

... read and follow the warnings and instructions of the explosives manufacturer and suppliers.

... retire to a safe place and WARN OTHERS before initiation of explosives. Be sure the blasting location is clear of others, including fellow workers or the general public (where applicable). In underground workings be sure that all entrances to the blast site are guarded against unauthorized entry.

... rotate stocks. Use the oldest units in your inventory first. Age affects the integrity of caps and other explosive devices.

... transport, store and use explosive products in accordance with all Federal, State and Local laws.

... dispose of or destroy NONEL products and all other explosives in accordance with approved methods. Consult the manufacturer or follow the IME statement of policy publication.

... remember that all safe practices required for and applicable to explosives generally apply to NONEL and detonating cord products. Proper storage requires not only security from theft or loss, but it requires that such products be kept from flame, heat and open lights such as smoking and matches, and heat such as stoves and radiators. It is especially important to keep detonating cord, primers and detonators from unintended initiating energy such as open flame. Remember that the shock tube can burn or that heat may seal it and cause misfires. If fire occurs, retreat to a safe distance and do not attempt to extinguish.

... evacuate personnel to a safe location away from possible detonation or explosion in the event of a lightning storm during surface use of these products.

... avoid situations where shock tube, detonating cord, or other initiation system components can be come entangled in machines, equipment, vehicles or moving parts thereof and prematurely initiate.

... keep explosive materials away from children, unauthorized persons and livestock.

... look for misfires and handle suspected misfires as you are directed by applicable Local, State and Federal laws and under the standards promulgated by the IME.

... wait at least 60 minutes with fuse detonator misfires, at least 30 minutes with electronic detonator misfires, and at least 15 minutes with electric and other nonelectric detonator misfires before returning to the blast area. Misfires shall be handled under the direction of the blaster.

... unhook surface delay connectors and connections prior to handling a misfire.

*The warnings listed are those that apply to nonelectric detonators and detonating cord. For a complete list of explosives warnings, please reference the Case Insert, found in each box of product, or the Institute of Makers of Explosives (IME) Safety Library Publication (SLP) #4.*

# NEVER

... cut or trim shock tube, and never remove or crimp a cap on shock tube. When tube is cut, moisture can enter and cause misfires. If you do not have the length or delay you want, DO NOT try to manufacture it. Special procedures pertain to Starter units.

... attach the primary initiator to the round or shot until after all the connections have been made and the blasting area has been cleared.

... load NONEL detonators or detonating cord into a hot hole, or expose them to temperatures above 66° C (150°F).

... leave loaded blast holes out of the main blast pattern tie-in. Loaded blast holes that are not tied in to the main pattern (shot break practice) may be initiated from the shock energy of an adjacent blast hole(s). This practice may cause damage to explosives and initiation systems, which may result in misfires. Misfires, unless handled properly, may result in injury or death.

... hold shock tube in your hand when initiating it. If you hold the tube in your hand when initiating it you may injure yourself or others because: a tube that has been mishandled or abused may rupture when initiated; the open end may be pointed at someone; or, if the cap has not been removed, the cap may initiate and kill or injure.

... pull, stretch, kink or put undue tension on the shock tube. This will affect the ability of the shock tube to propagate through damaged sections.

... extract explosive material from a blasthole that has misfired unless it is impossible or hazardous to detonate the unexploded explosive materials by insertion of an additional primer.

... assemble the NONEL product and the cast booster until you are ready to deploy it into the borehole.

... hook-up a surface delay connector before you are ready to fire the blast.

... hook-up a surface connector to its own shock tube.

... attempt to initiate detonating cord with a surface delay connector designed for the initiation of shock tube only.

... put explosives materials in pockets of your clothing.

... use NONEL products in fireworks or pyrotechnic displays.

... use explosive materials that appear to be damaged or deteriorated. Before using consult your supervisor or the manufacturer.

... burn explosive materials packaging in a confined space.

... leave an un-hooked surface delay connector in close proximity to the shock tube of a loaded blasthole.

... drive any vehicle over shock tube. Tube may get tangled in machinery, stretching it to breaking point so that it snaps and recoils, producing a high velocity whiplash action. If the exposed core impacts a hard surface during this action, initiation may occur. Such firing may cause serious misfires if the detonator is initiated.

... fight fires involving explosives materials. Remove yourself and all other persons to a safe location and guard the area.

... attempt to knot shock tube together, shock tube will not initiate itself through knot connections.

... put undue tension on shock tube leads. The lead may break, creating a “snap, slap & shoot” situation which could cause unintended initiation of the shock tube lead.

*The warnings listed are those that apply to nonelectric detonators and detonating cord. For a complete list of explosives warnings, please reference the Case Insert, found in each box of product, or the Institute of Makers of Explosives (IME) Safety Library Publication (SLP) #4.*

# Connectors and Connections

## EZ Connector™ Blocks

1. Insert one shock tube at a time into the connector block to prevent the possibility of shock tube crossovers in the connector block. The head of the connector block should rise to accept the shock tube and return to a closed position with an audible click.
2. After inserting all the shock tube(s) securely into the surface connector, slide the connector to seat the shock tube(s) and release any crossovers.

**N**ever use the EZ Connector block with detonating cord. Misfires may occur.

An EZ Connector block can accommodate 1 to 6 shock tube(s).

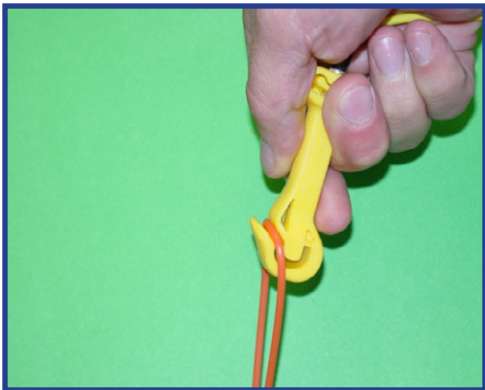

Figure 4 - Correct insertion of shock tube into EZ Connector block; one at a time.

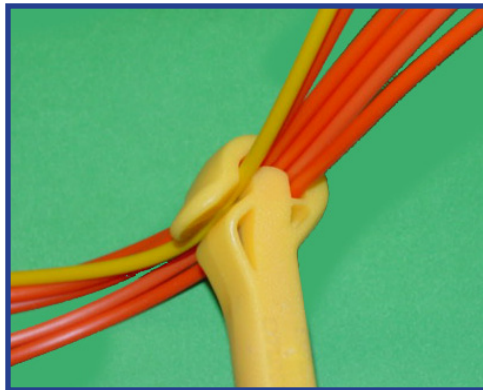

Figure 5 - Six shock tube leads correctly seated in the EZ Connector block.

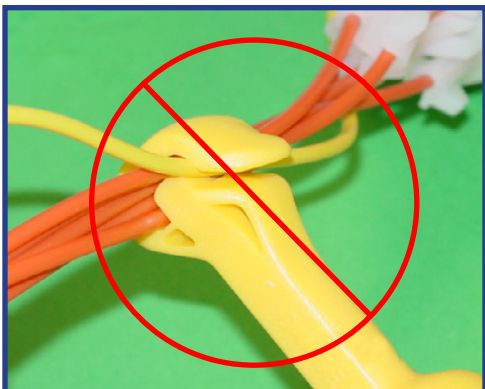

Figure 6 - Incorrect insertion of shock tube in the EZ Connector block; tube not fully inserted.

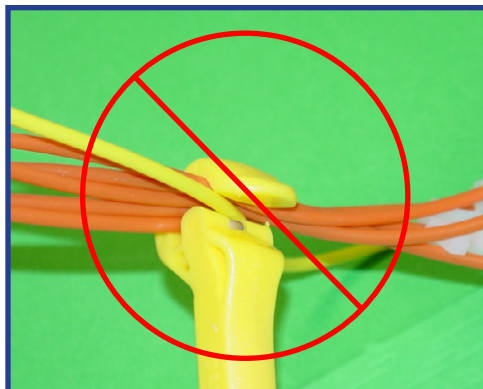

Figure 7 - Shock tube leads incorrectly seated. Yellow lead is crossed-over; mis-fire may result.

## Bunch Block

### With Shock Tube

1. Place all downlines and outgoing trunkline leads in the Bunch Block with the cap pointing in the direction of initiation and the tails behind the Bunch Block (Figure 8).
2. Snap the lid of the Bunch Block closed. Make sure it is closed tightly.
3. Make sure all outgoing shock tube leads are properly positioned and leave the Bunch Block in a straight line for at least 1 m (3 ft). Never bend the tubes around the nose of the Bunch Block (Figure 11), back over the top of the Bunch Block, or allow the outgoing trunkline(s) to loop back near the Bunch Block. Any of these may result in a cut-off due to shrapnel from the exploding Bunch Block.

**N**ever attempt to disassemble the delay detonator from the plastic connector block or use the cap by itself without the block.

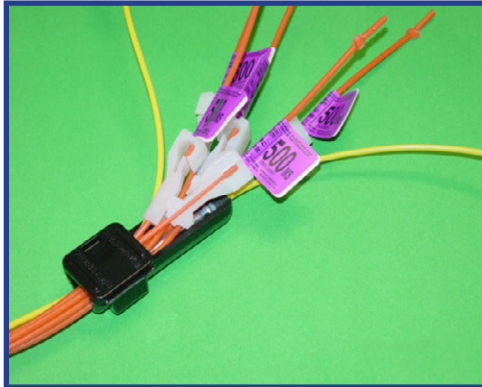

Figure 8 - Shock tube correctly inserted into Bunch Block.

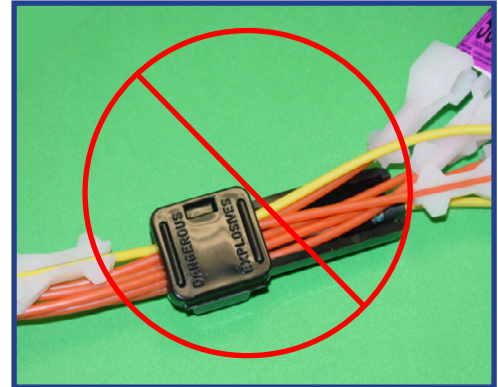

Figure 9 - Shock tube incorrectly inserted into Bunch Block; yellow lead not in direction of initiation.

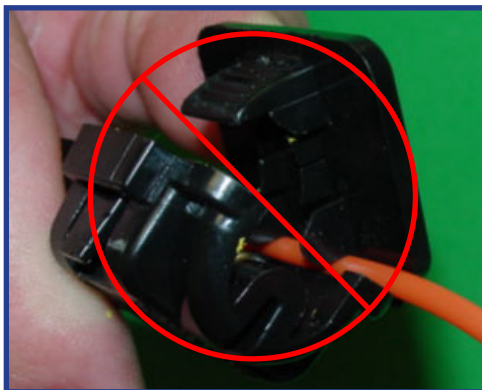

Figure 10 - Shock tube incorrectly inserted into Bunch Block; under hinge, misfire may occur.

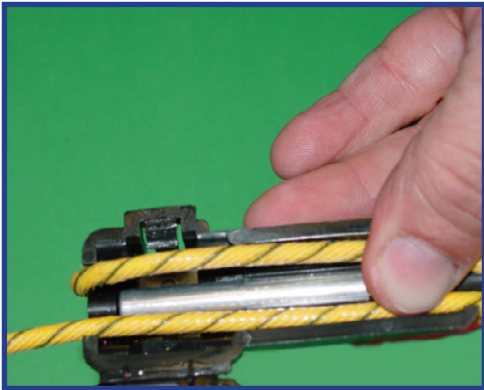

Figure 11 - Shock tube bent around nose of Bunch Block. Cut-off may result.

## With Detonating Cord

1. Place the detonating cord in the Bunch Block parallel to the detonator.
2. Wrap the detonating cord around the bottom of the Bunch Block and then back in the Bunch Block parallel to the detonator and snap the lid firmly closed.
3. Trim excess detonating cord tails. Any extraneous contact of detonating cord and the shock tube connections may result in a cut-off.

**A**lways remember surface connectors contain detonators and are subject to detonation caused by abuse such as impact, the same as all detonators.



**Figure 12 - Correct insertion; block open, detonating cord laid parallel to detonator and wrapped around Bunch Block.**

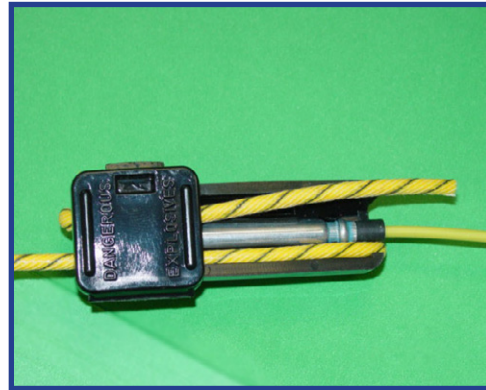

**Figure 13 - Correct insertion; block closed, detonating cord laid parallel to detonator and wrapped around Bunch Block.**

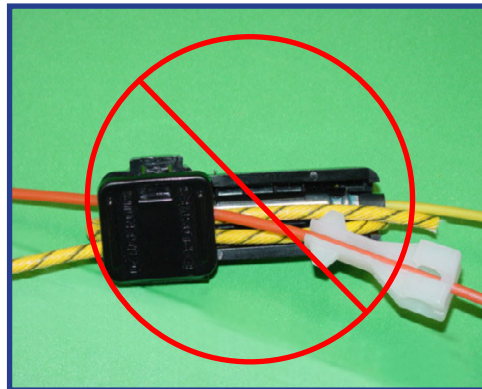

**Figure 14 - Incorrect use of Bunch Block. Shock tube and detonating cord should NEVER be in the same block.**

# NONEL<sup>®</sup> nonelectric delay detonators

## NONEL EZ DET<sup>®</sup>

### Loading Procedures

#### For solid column loaded holes

1. Lower an EZ DET/primer assembly into the borehole and secure the surface relay at the borehole collar.
2. Load explosive material into the borehole.
3. Lower a MS/primer assembly of the appropriate delay to the top of the explosive column. If double trunkline or twin-path hook-up is desired, a second EZ DET/primer assembly can be used.

#### For deck loaded holes

1. Repeat the procedure for solid column holes.
2. Load stemming material for decking.
3. Repeat these steps until the appropriate number of decks are completed.

**N**ever use the EZ DET system with detonating cord. Misfires may occur.

### Use in Surface Hook-up

After all boreholes have been loaded with the NONEL EZ DET unit(s) and properly stemmed, the surface hook-up can be made as follows:

1. Attach the EZ Connector end of the EZ DET detonator coming from the hole to be fired first in the blast onto the shock tube(s) of the EZ DET detonator from the second hole. Be sure the shock tube is properly inserted into the surface connector (see EZ Connector instructions on page 10).

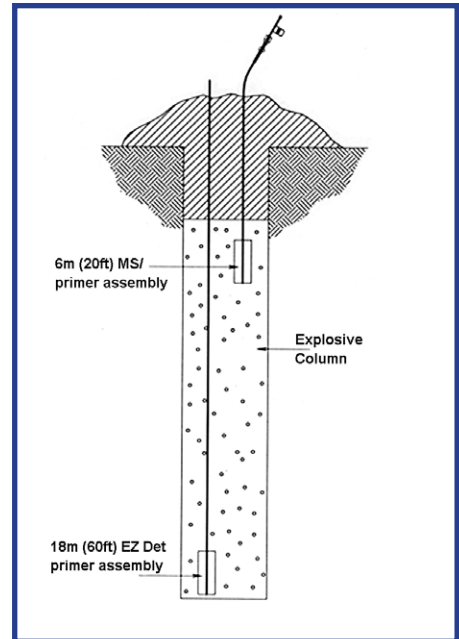

Figure 15 - Solid column loaded hole.

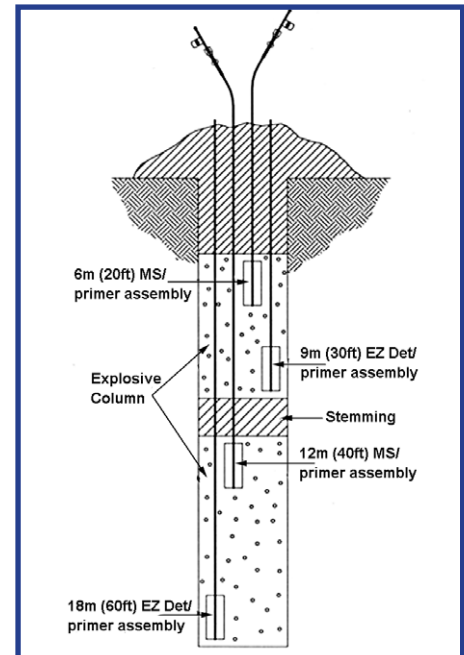

Figure 16 - Deck loaded hole.

2. Slide the surface connector along the shock tube(s) to ensure all are fully engaged and release any crossovers. Place the blocks consistently to one side of the collar.
3. Repeat the above process until all holes have been connected using the surface connectors.

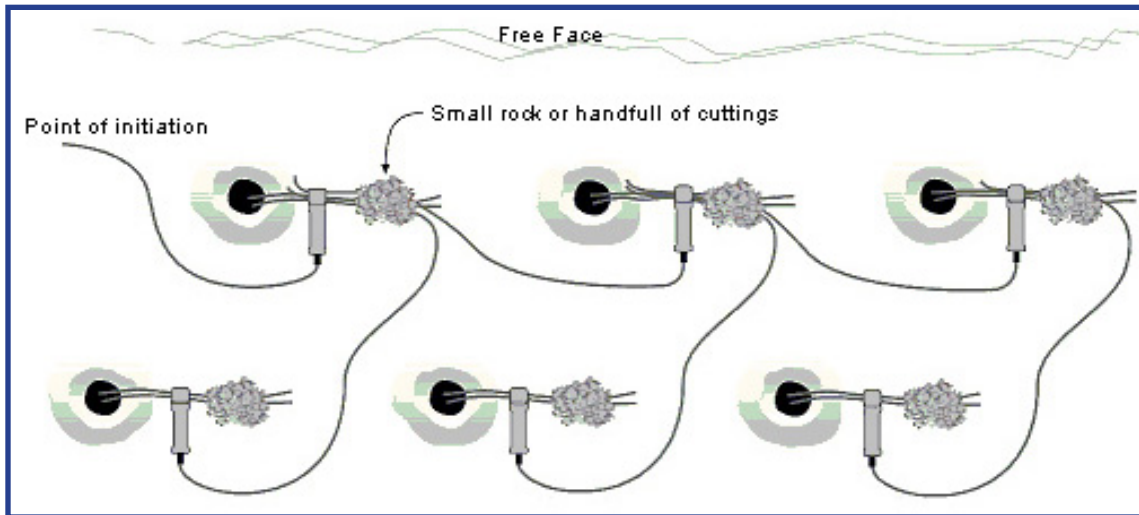

Figure 17 - EZ DET detonator surface connection layout.

To provide a surface delay between rows of EZ DET units, insert the shock tube(s) of a NONEL TD or EZTL detonator into the surface connector of the EZ DET. When using TD units, attach the incoming TD unit to the EZ DET unit's shock tube leads in both directions following the Bunch Block instructions (page 11). If EZTL units are used, be sure they are properly attached to the shock tube(s).

Once all connections are complete, make a thorough inspection of the hook-ups for proper connection. Turn any Bunch Blocks upside down and cover with drill cuttings, stemming or other similar material to prevent cut-offs and to control noise. The surface connector end of the EZ DET detonator from the last hole of each row in the blast is an extra connector and should be kept separate to keep the connections neat and prevent any confusion.

### Connection Inspection

Double check all connections before moving on to the next hole. Once all holes are connected, do a final inspection after all holes are connected by walking the shot looking for:

- Correct connection of all holes and shock tubes

If the shot is to be covered with blasting mats and/or backfill material, cover surface connectors with at least 15 cm (6 in) of gravel or drill cuttings. Backfilling and matting of shots should be done carefully to avoid any damage to the surface connector and EZ DET leads, which may result in a misfire or premature detonation.

- All tubes fully in the block
- Connecting tubes are neat but not tight and run at right angles to the connection and do not loop back.

When the inspection is complete, secure the blast area and ensure the connections are not disturbed. Perform the connection inspection again if the shot sits unfired for any length of time or if there is any possibility the connections may have been disturbed.

### Special Applications - Trench Blasting

EZ DET detonators are ideal for various types of trench blasting. EZ DET units can accommodate both simple and complex trench blasting design patterns. 25/350ms EZ DET units provide an unlimited number of constant, precise 25ms delay intervals between holes and/or decks in trench blasting applications. 350ms in-hole detonators minimize the risk of cut-off downlines or trunklines due to ground movement, since the actual detonation time of the blast hole is greater than the surface detonation time.

**N**ever wrap tube around top of the EZ Connector block and back into block (double wrap) shock tubes in the connector block.

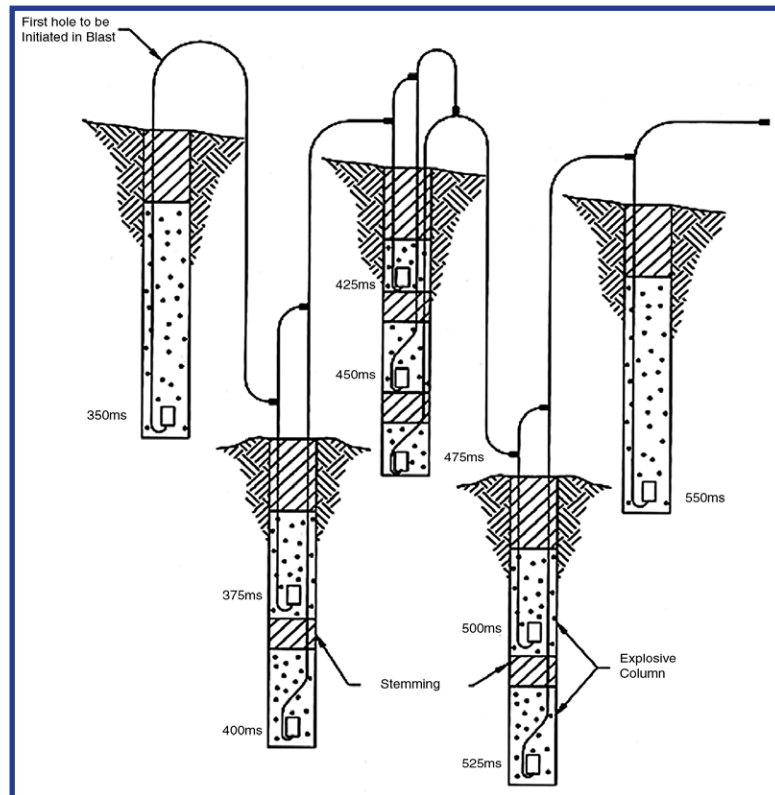

Figure 18 - EZ Det in Trench Blasting



# NONEL EZ DRIFTER®

## Shot Hook-up

1. Connect the surface connector from the first hole to the shock tube of the second hole, following the EZ Connector block instructions on page 10. Be sure the shock tube(s) is properly inserted into the connector block.
2. Slide the surface connector to the collar of the hole.
3. Repeat the above process; connecting the previous hole's connector block to the next hole's shock tube - until all holes are connected.

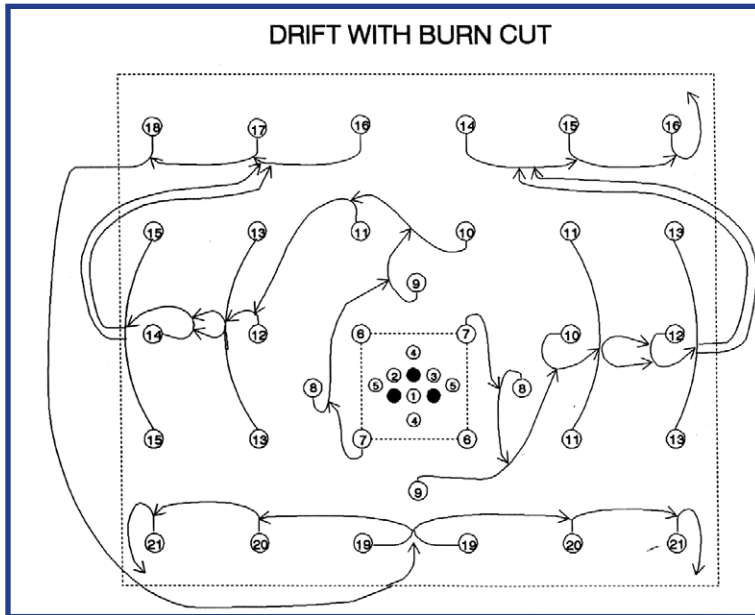

Once all the holes in the pattern are connected, check to make sure all tubes are properly inserted in the connector block, all holes are tied-in to the shot, and that there are no more than 6 tubes in each surface connector.

Figure 19 - Drift with burn cut.

**N**ever use EZ DRIFTER with detonating cord, misfires may occur.

**N**ever wrap tube around top of EZ Connector block and back into block (double wrap) shock tubes in the connector block.

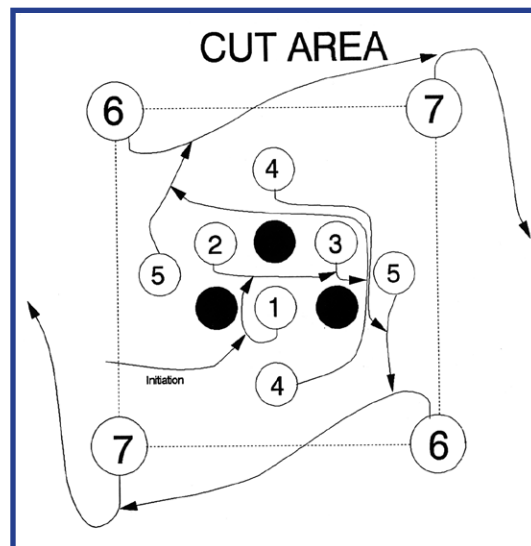

Figure 20 - Cut area layout with EZ DRIFTER.

## NONEL EZTL™

### *As a Surface Delay for the EZ DET System*

Once all the boreholes have been loaded with the EZ DET system and properly stemmed, EZTL units can be used as a surface delay with the EZ DET system in the following manner:

1. Follow the instructions for “Use in Surface Connections” in the EZ DET section to hook-up the EZ Det units.
2. To provide a surface delay between rows of EZ DET units, insert the shock tube(s) of an EZTL unit into the surface connector of the EZ DET.
3. Attach the surface connector of the incoming EZTL detonator to the shock tube(s) of the EZ Det unit at the next row.
4. After inserting the shock tube(s) securely into the surface connector, slide the surface connector along the shock tube(s) to ensure all are fully engaged and release any crossovers. Place blocks consistently to one side of the hole collar.
5. Thoroughly inspect the hook-ups for proper connection after all the blast holes are connected.
6. The surface connector of the EZ DET detonator from the last hole of each row in the blast is an extra connector and should be kept separate to keep the connections neat and prevent any confusion.
7. Be sure the shock tube(s) line up in a single row and do not cross behind or in front of one another when inserting more than one shock tube into the surface connector; allowing the shock tube to cross may result in a misfire.

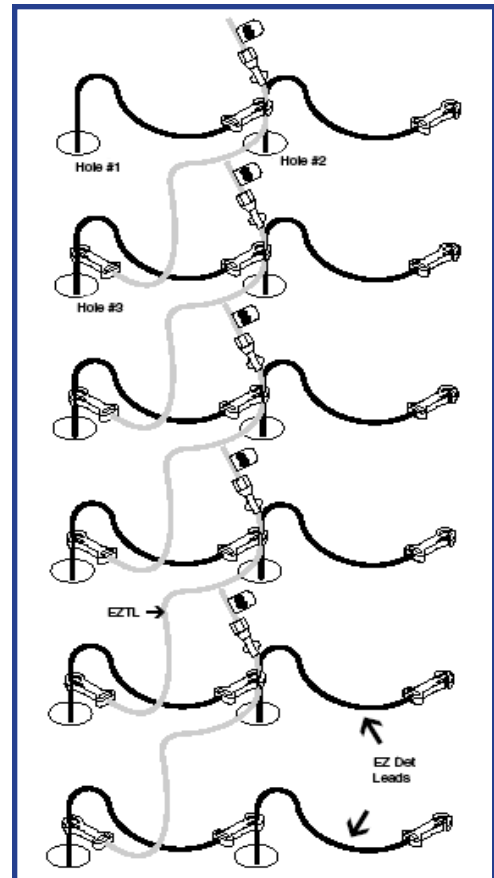

*Figure 21 - EZTL detonator surface connection layout.*

**N**ever wrap tube around top of EZ Connector block and back into block (double wrap) shock tubes in the connector block.

## As a Surface Delay for MS or LP Detonators

Refer to the blast plan to layout the correct EZTL detonator at the collar of each blasthole. Then, at each hole:

1. Place all shock tube downlines and outgoing trunkline leads into the EZTL unit EZ Connector. Be sure the shock tube(s) is properly inserted into the connector block.
2. After inserting the shock tube(s) securely into the surface connector, slide the surface connector along the shock tube to ensure all are fully engaged and release any crossovers. Place all blocks consistently to one side, ensuring there are no sharp bends and that the shock tube does not loop back across or near the block.
3. Repeat this process until all the holes have been connected using the EZTL surface connectors.
4. After all of the blast holes are connected, thoroughly inspect the hook-ups for proper connection and to ensure that hook-up is not accidentally disturbed by unauthorized personnel or traffic.

**N**ever use EZTL detonators with detonating cord, misfires may occur.

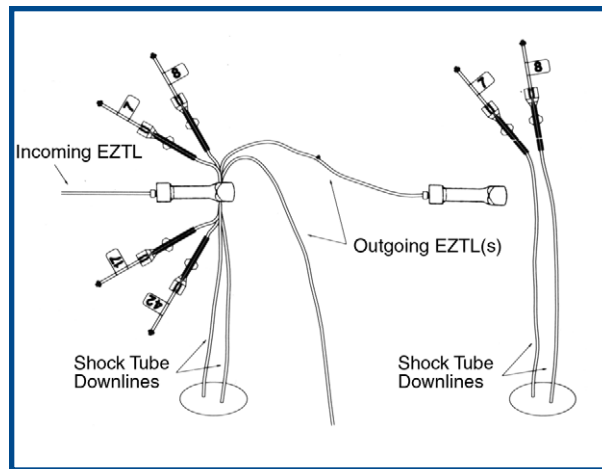

Figure 22 - Proper hook-up of EZTL unit at the hole collar.

## Connection Inspection

Double check all connections before moving on to the next hole. Once all holes are connected, do a final inspection by walking the shot to look for:

- Correct connection of all holes and shock tubes
- All tubes fully in the block
- Connecting tubes are neat but not tight and run at right angles to the connection and do not loop back.

The direction in which EZTL units are connected to the blast holes, as well as the in-hole delay time, determines the sequence of blast hole detonation. The choice of delay times determines the time interval between detonation.

When the inspection is complete, secure the blast area and ensure the connections are not disturbed. Perform the connection inspection again if the shot sits unfired for any length of time or if there is any possibility the connections may have been disturbed.

## NONEL Lead Line

Lead Line is used to extend the initiating unit from the shot to a position of safety

1. Select the appropriate NONEL surface delay detonator to initiate your shot.
2. Use a razor blade or sharp knife to cut a minimum of 1 m (3 ft) from the end of the NONEL Lead Line spool to minimize the effect of moisture contamination in the shock tube. Make sure the cut is square (Figure 23).
3. Spool out the Lead Line to a predetermined place of safety.
4. Insert the newly cut Lead Line end into the splice. Remove the vinyl end protector and insert the cut end of the surface delay detonator into the shock tube splice. Both ends should be inserted into the splice a minimum of  $\frac{1}{2}$  cm ( $\frac{1}{4}$  inch) and firmly seated in the splice.

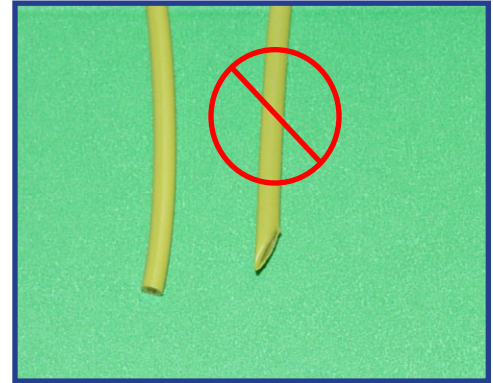

*Figure 23 - Correct, square cut on left; incorrect cut on right.*

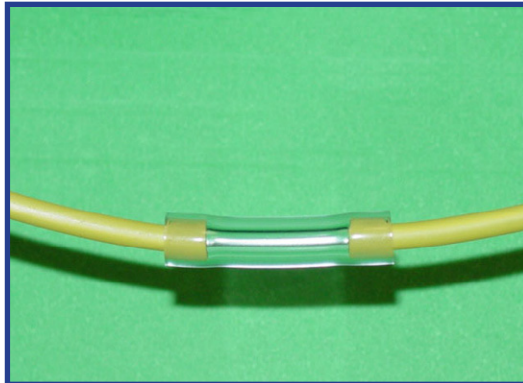

*Figure 24 - Proper insertion of shock tube into splice. Tubes do not need to be butted against each other.*

**N**ever use any device other than Lead Line splices to connect trunklines together.

**N**ever use Lead Line shock tube that has been subjected to severe moisture conditions.

**N**ever attempt to initiate Lead Line shock tube when used as a NONEL Starter with anything other than a starter for shock tube.

**N**ever reuse shock tube splices.

**N**ever cut and splice shock tube leads unless they are being used as the primary initiator of the shot, and they are spliced to Lead Line.

**N**ever trim ends until immediately prior to use. The end seal protects the shock tube from moisture contamination, which may prevent the proper transmission of the shock tube signal.

5. Cut the shock tube from the spool and cover its end with a vinyl end protector. Cover the cut end remaining on the spool with a vinyl end protector (Figure 25) and remove the spool from the blast site.
6. When the blaster in charge is ready to fire the blast, remove the vinyl end protector and insert the Lead Line into the starter of choice. Dyno Nobel recommends periodic cleaning of the shock tube starter to ensure dust, carbon, etc. don't hinder its safe operation. Follow the manufacturer's instructions to clean and operate the starter.

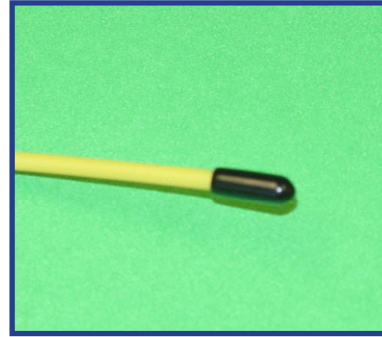

**Figure 25 - Cut end of Lead Line covered with vinyl end protector to prevent moisture contamination.**

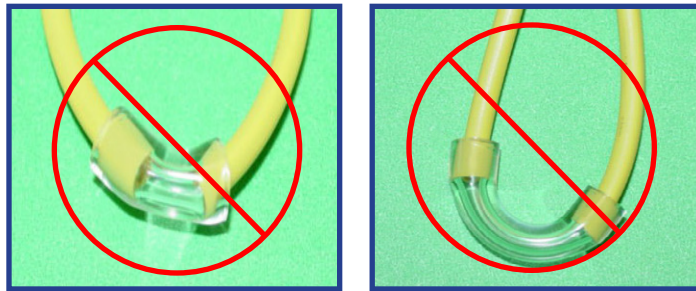

**Figure 26 - Incorrect insertion of shock tube into splice. On the left, the splice has been shortened, and on the right the splice has been bent. Both situations could lead to a misfires, which may kill or injure.**

**A**lways keep the vinyl end protector on the open end of Lead Line shock tube. Moisture in the tube may cause misfire.

**A**lways make a clean, square cut with a sharp knife or razor blade when trimming shock tube products for splicing.

**A**lways make sure trunklines are firmly inserted into the splice.

**A**lways store Lead Line in a dry place.

**A**lways trim 1m (3 ft) from the end of the Lead Line spool prior to use. This is to safeguard against adverse conditions which may have affected the shock tube during shipment or storage.

**A**lways keep the splice and cut ends of the shock tube dry and free of dirt and other debris when splicing Lead Line. Foreign material in the shock tube or splice may cause a misfire, which may kill or injure.

**A**lways connect shock tube lengths with a clean shock tube splice.

**A**lways shield the interior of shock tube from rain, wet ground, extended exposure to high humidity and other similar conditions when assembling components in the field. The entrance of moisture into the tube may cause it to malfunction.

## NONEL LP

### Loading with Cartridged High Explosives

LP detonators are ideally suited for use with commercially available dynamites or other similar cap sensitive high explosives because the tube will not initiate or disrupt these explosives.

1. Check the hole for obstructions with a tamping pole or loading hose of sufficient diameter.
2. Using an approved powder punch, punch a hole in the primer cartridge deep enough to accept the entire cap shell and bushing. Be sure the cap is centered axially in the cartridge. The shock tube may be half-hitched around the cartridge if necessary.
3. Place the primer assembly in the hole so the end of the detonator points toward the collar of the hole. DO NOT directly tamp on the primer assembly (Figure 27).
4. Place two or more cartridges in the hole and tamp.
5. Repeat until hole is loaded.

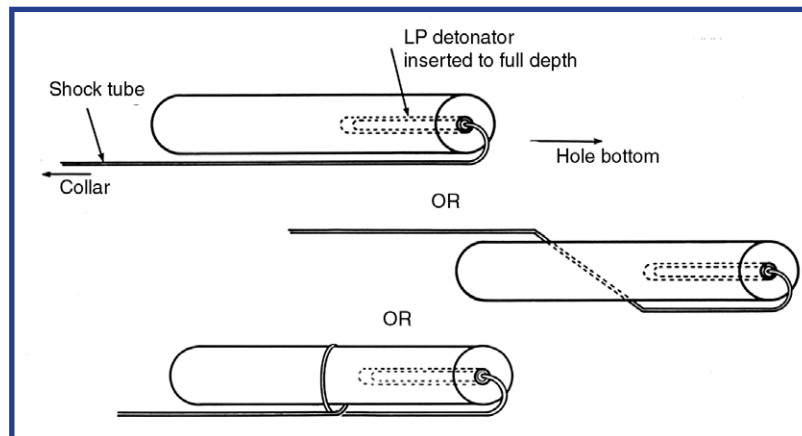

Figure 27 - Methods to insert LP detonator into explosive cartridge.

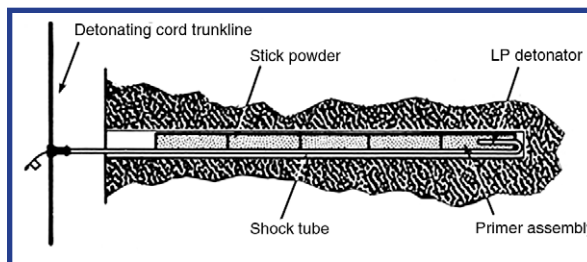

Figure 28 - Hole loaded with stick powder and LP assembly at bottom.

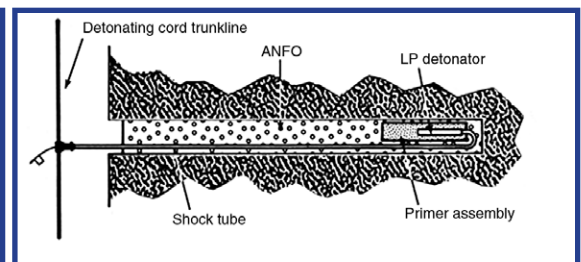

Figure 29 - Hole loaded with ANFO and LP assembly at bottom.

## Connecting Shock Tube to Detonating Cord Using J-Hooks

Dyno Nobel recommends Primacord detonating cords specifically designed as trunklines for the initiation of shock tube through J-hook connections. All LP detonators are supplied with J-hook attachments, which work with drift, stope or shaft rounds.

1. Connect the J-hook of each lead to the detonating cord trunkline.
2. Be sure the shock tube is connected to the detonating cord at right angles and is pulled tight from the drill hole to the detonating cord trunkline. Make all J-hook connections at least 20 cm (8 in) from all detonating cord knots. Do not allow slack in the shock tube going from the J-hook to the collar of the drill hole; if the detonating cord touches the shock tube or is closer than 15 cm (6 in), the tube may be severed rather than initiated upon detonation.

**A**lways cut a “V” slot in the loading hose to prevent abrasion of shock tube during loading.

**A**lways be sure NONEL connections are at right angles (90°) to the detonating cord trunklines to prevent angle cut-offs.

**A**lways be sure the shock tube leading to the hole is in a straight line and is taut. Connections must be made so the shock tube leading to the collar does not come in contact with the detonating cord trunkline between the connection and borehole collar.

**A**lways place detonating cord trunkline hook-ups in closed loops and use with crossties. Two paths of initiation will then be available for each detonator connection.



*Figure 30 - Correct connection of J-Hook to detonating cord trunkline.*



*Figure 31 - Incorrect connection of J-Hook to trunkline; shock tube lead crosses over trunkline. Cut-offs or misfires may result.*

## NONEL MS

### For solid column loaded holes

1. Lower an MS/primer assembly into the borehole and secure the end of the shock tube at the collar.
2. Load explosive material into the borehole.
3. Lower a second MS/primer assembly to the top of the explosive column and finish loading the hole, ensuring the primer is at a depth of at least 60 cm (2 ft) in the explosive column.

**A**lways attend downlines during loading of explosives and/or stemming materials.

### For deck loaded holes

1. Lower an MS/primer assembly into the borehole and secure the end of the shock tube at the collar.
2. Load explosive material into the borehole.
3. If the bottom charge is to be double primed, lower a second MS/primer assembly of the same delay to the top of the explosive charge, and finish loading the hole, ensuring the primer is at a depth of at least 60 cm (2 ft) in the explosive column.
4. Load stemming material for decking.
5. Repeat the above procedure until the appropriate amount of decks are completed.

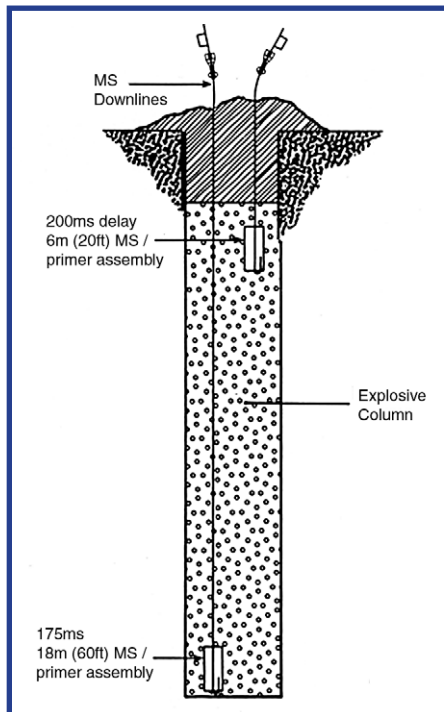

*Figure 32 - MS primer assemblies in solid column loaded hole.*

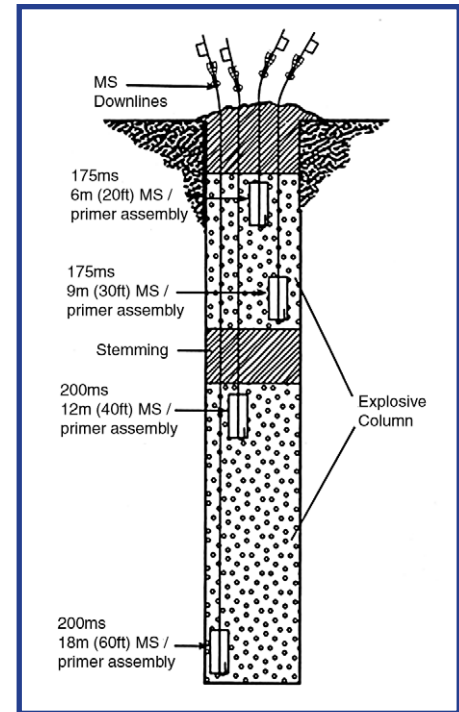

*Figure 33 - MS primer assemblies in deck loaded hole.*



## Connecting MS Detonators to Detonating Cord Trunkline Using J-Hooks

1. Dyno Nobel recommends Primacord detonating cords specifically designed as trunklines for the initiation of shock tube through J-hook connections.
2. Using the J-hook provided, connect each lead to the detonating cord trunkline.
3. Make sure shock tube is at right angles to detonating cord trunkline. If shock tube touches or is closer than 15 cm (6 in) to the detonating cord it may be severed rather than initiated upon detonation.
4. From the J-hook pull the sealed end of the MS lead tight and directly in line with the borehole. DO NOT allow slack in the shock tube going from the J-hook to the collar of the borehole.



Figure 34 - Correct J-Hook connection.



Figure 35 - Incorrect J-hook connection. Crossover may cause cut-offs or misfires.

## Hook-up of MS Detonators with TDs

1. Follow the Bunch Block connection instructions on page 11.
2. After all blast holes are connected, make a thorough inspection of hook-ups for proper connection; ensuring all tubes leave the block in a straight line for at least 1 m (3 ft).
3. Turn each Bunch Block upside down and cover with drill cuttings, stemming or other similar material to prevent cut-offs and control noise.

**A**lways be sure shock tube connections are at right angles (90°) to the detonating cord trunklines to prevent angle cut-offs.

**A**lways be sure the shock tube leading to the hole is in a straight line and is taut.

**A**lways place detonating cord trunkline hook-ups in closed loops and use with crossties. Two paths of initiation will then be available for each detonator connection.

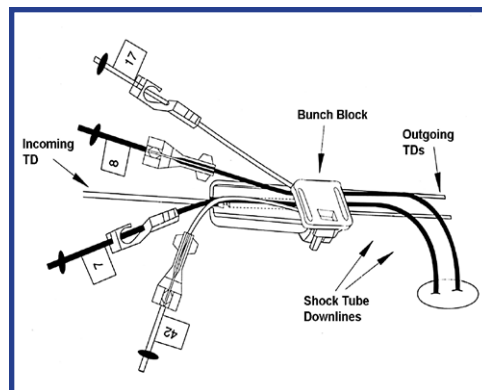

Figure 36 - MS downlines and TD trunklines correctly in TD bunch Block.

## NONEL MS Connector

### *Use as a Surface Delay with Detonating Cord*

These instructions apply to detonating cord with a coreload of 3.6 g/m (18 gr/ft) and higher.

First, select the location in the detonating cord trunkline to insert the MS Connector and cut the detonating cord. Then wrap the cord around the cleats in the following manner:

**N**ever cut detonating cord with devices that produce metal-to-metal contact, such as scissors, wire cutters, crimpers or similar instruments.

1. Place the detonating cord in the groove of the connector block, with about 23 cm (9 in) protruding out the same end of the connector block as the shock tube lead.
2. Wrap the tail of the detonating cord around both cleats of the connector block so that the detonating cord snaps into the securing feature of the connector block.
3. Wrap the tail of the detonating cord around both cleats again, so the cord snaps into the securing feature of the connector block, locking the cord in place.

Repeat the above steps to connect the other end of the detonating cord trunkline to the second connector block. Once both connections are made, cut the detonating cord tails to ensure they do not come in contact with or come near the shock tube lead.

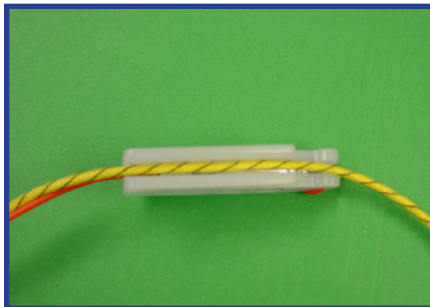

*Figure 37 - Step 1, cord in center groove.*

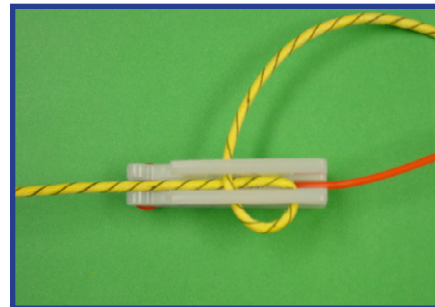

*Figure 38 - Step 2, cord wrapped around one cleat.*

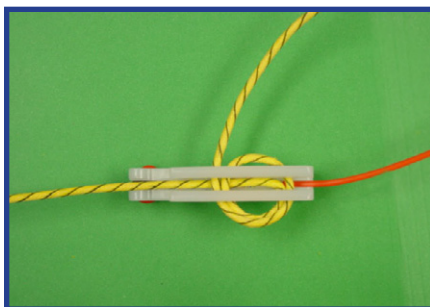

*Figure 39 - Step 3, cord wrapped around both cleats.*

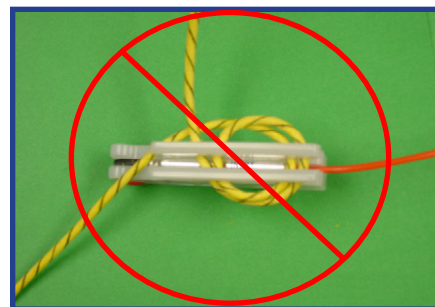

*Figure 40 - Incorrect MSConnector connection. Cord not in center groove.*

## Use as a Surface Delay with PRIMACORD 2 (10 gr/ft)

Select the location in the PRIMACORD 2 detonating cord trunkline to insert the MS Connector and cut the trunkline. Then make the connections in the following manner:

1. Place the PRIMACORD 2 in the center groove of the connector block, with about 23 cm (9 in) protruding out the same end of the connector block as the shock tube lead (Figure 41).
2. Wrap the PRIMACORD 2 around one cleat of the MSConnector and back up the center groove (Figure 42).
3. Wrap the PRIMACORD 2 around the other cleat of the MSConnector and back up the center groove (Figure 43).
4. To complete the connection, wrap the PRIMACORD 2 around both cleats and secure it in the locking device at the end of both cleats (Figure 44); the finished connection should resemble a Figure 8.

**A**lways remember connector blocks contain detonators, and are subject to detonation caused by abuse, such as impact, the same as all detonators.

**A**lways place MS Connectors close to the hole being delayed to eliminate ground movement cut-offs from the preceding hole.

**A**lways ensure the detonating cord is properly inserted and secured in the MS Connector.

Repeat the above steps to connect the other end of the PRIMACORD 2 trunkline to the second connector block. Once both connections are made, cut the detonating cord tails to ensure they do not come in contact with or come near the shock tube lead.

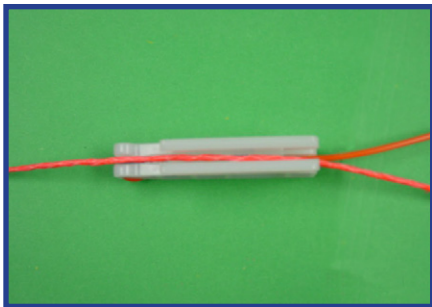

Figure 41 - Step 1, cord in center groove.

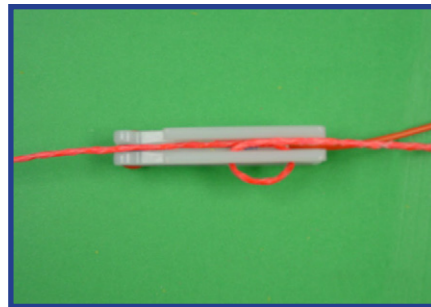

Figure 42 - Step 2, cord around one cleat and back in center groove.

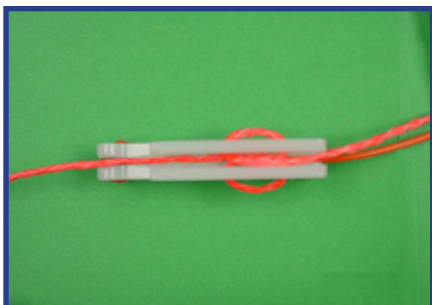

Figure 43 - Step 3, cord around second cleat and back in center groove.

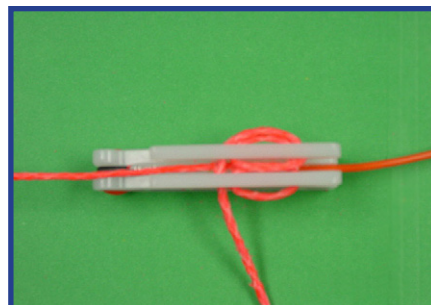

Figure 44 - Step 4, cord around both cleats and secured.

## NONEL SL

### Loading Procedures

Dyno Nobel recommends Primacord 1 (7.5 gr/ft), Primacord 3 (15 gr/ft) and/or Primacord 4R (18 gr/ft) for use as downlines to NONEL SL detonators.

#### For solid column loaded holes

1. Insert a SL detonator of the appropriate delay into a booster.
2. Attach detonating cord to the SL loop with a double-wrap clove hitch.
3. Lower the SL/primer assembly into the hole and cut the detonating cord from the spool at the hole collar.
4. Load the explosive material charge (insensitive to Primacord 1, Primacord 3 or Primacord 4R) into the hole.
5. Repeat this process for the remaining holes of the shot.

#### For deck loaded holes

1. Insert a SL detonator of the appropriate delay into a booster.
2. Attach detonating cord to the SL loop with a double-wrap clove hitch.
3. Lower the SL/primer assembly into the hole and cut the detonating cord from the spool at the collar of the hole.
4. Load the explosive material charge (insensitive to Primacord 3, Primacord 4Y, Primacord 4R or Primacord 5) into the hole. If the bottom charge will be double primed, lower a second SL/primer assembly of the same delay to the top of the explosive charge, ensuring the primer is at a depth of at least 60 cm (2 ft) in the explosive column.

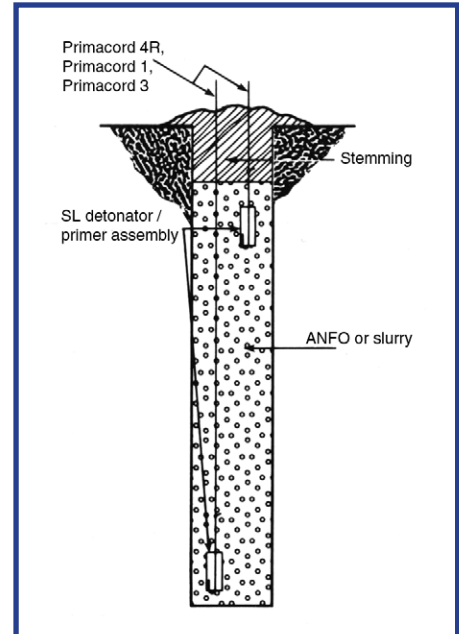

Figure 45 - SL units in solid column loaded hole.

**A**lways cut the detonating cord from its spool as soon as the primer assembly is in place.

**A**lways use a minimum of two primers, one at the bottom and one at the top of the column, in holes larger than 23 cm (9 in) in diameter, or in explosive material columns longer than 9 m (30 ft).

**A**lways use a pigtail of Primacord 4R, Primacord 4Y or Primacord 5 to initiate outgoing shock tubes. Primacord 1 is not a reliable initiator of NONEL TD units.

**A**lways use only continuous lengths of detonating cord to connect the SL detonator. Splices must not be put in the hole.

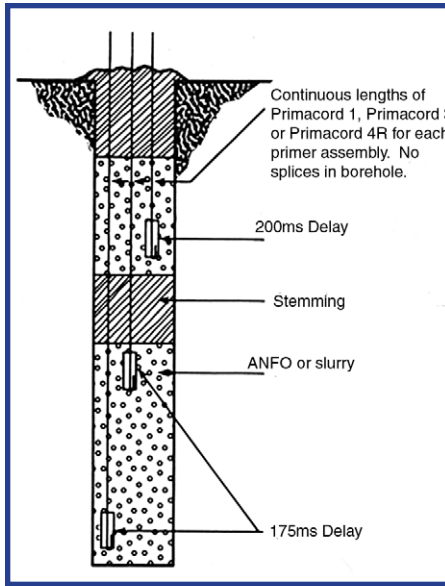

Figure 46 - SL units in deck loaded hole.

5. Load the stemming material for the deck.
6. For the second deck, make up another SL/ primer assembly of the correct delay and lower it into the borehole on a separate detonating cord downline. Cut the cord at the hole collar.
7. Load the explosive material, and stem the deck.
8. Repeat these steps for the desired number of decks.

### For deck loaded holes with sliding delay primers

1. Insert a SL detonator of the appropriate delay into a booster.
2. Attach detonating cord to the SL unit loop with a double-wrap clove hitch.
3. Lower the SL/primer assembly into the hole and cut the detonating cord from the spool at the collar of the hole.
4. Load the explosive material charge (insensitive to Primacord 3, Primacord 4Y, Primacord 4R or Primacord 5) into the hole. If the bottom charge will be double primed, make up a second SL/ sliding delay primer and slide it down the detonating cord downline, ensuring the primer is at a depth of at least 60 cm (2 ft) in the explosive column.
5. Load the stemming material for the deck.
6. For the second deck, make up another SL/sliding delay primer assembly of the correct delay and slide it down the detonating cord downline.
7. Load the explosive material, and stem the deck.
8. Repeat these steps for the desired number of decks.

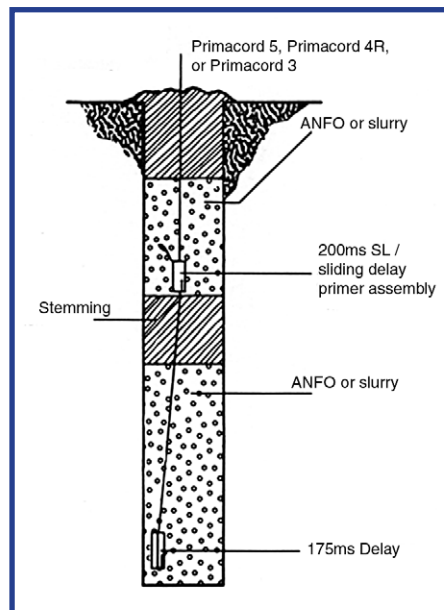

Figure 47 - SL units in deck loaded hole, using sliding delay primers.

**A**lways be sure to use a separate Primacord 1 downline for each primer assembly.

**A**lways use ANFO or blasting agents with similar properties (i.e. slurries or water gels) with Primacord 1, Primacord 3, and Primacord 4R. Certain cap sensitive explosive materials such as nitroglycerin-based explosives are sensitive to, and may be initiated by, these cords.

## Making NONEL SL/Sliding Delay Primer Assembly

1. Pass the cap down through the slider tunnel.
2. Reverse back through the center cord tunnel.
3. Bend 180° again and insert the cap to full depth into the cap well.
4. Pass the end of the detonating cord downline into the lower end of the slider tunnel and out the upper end so that the primer will slide freely down the borehole into position.

**A**lways use Primacord 1, Primacord 3, Primacord 4R, Primacord 4Y, or Primacord 5 as the downline. These coreloads are high enough for optimum initiation of SL units and low enough to minimize disturbance of non cap-sensitive explosive materials in the column, ensuring point initiation.

**A**lways be sure to separate detonating cord downlines during loading and stemming procedures to prevent cut-offs. Do not allow excessive slack to fall back down into the hole.

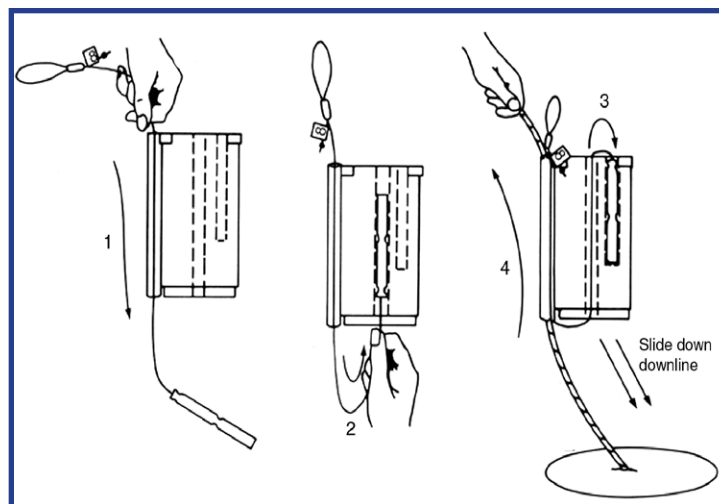

**Figure 48 - Making the SL / sliding delay primer assembly.**

When using SL detonators in the slider configuration, a 3.2 to 5.3 g/m (15 to 25 gr/ft) detonating cord downline is required; Dyno Nobel recommends Primacord 3, Primacord 4R, Primacord 4Y or Primacord 5.

## NONEL TD

The NONEL TD system is best suited for applications that require more delay intervals due to vibration limitations, but cannot have detonating cord trunklines because of overpressure (air blast) restrictions. Large blasts that require multiple delay intervals can be achieved by combining NONEL MS detonators with TD units.

NONEL TD units can be used with either shock tube or detonating cord. In both applications, the cap MUST be pointed in the intended direction of initiation.

### Use with Shock Tube

When used with shock tube, the NONEL TD system, in its simplest form, has one or two NONEL MS detonators down the hole and one incoming and one or two outgoing TD units.

1. Make the Bunch Block with shock tube connection, as detailed on page 11.
2. Once all holes are connected, thoroughly inspect all hook-ups for proper connection.
3. Turn the Bunch Block upside down and cover it with drill cuttings, stemming or another suitable material to help prevent cut-offs and control noise.

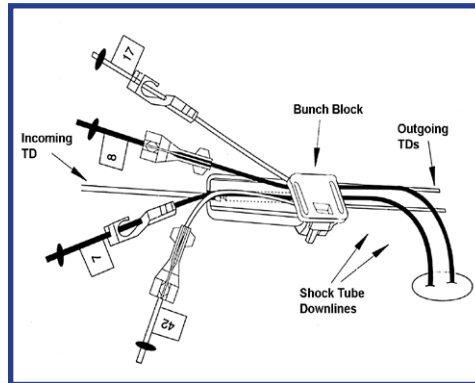

Figure 50 - TD unit block with shock tube.

**A**lways make sure shock tube downline connections are at right angles to the trunkline to avoid the possibility of cut-offs.

**A**lways consult the manufacturer for detonating cord compatibility with NONEL TD units.

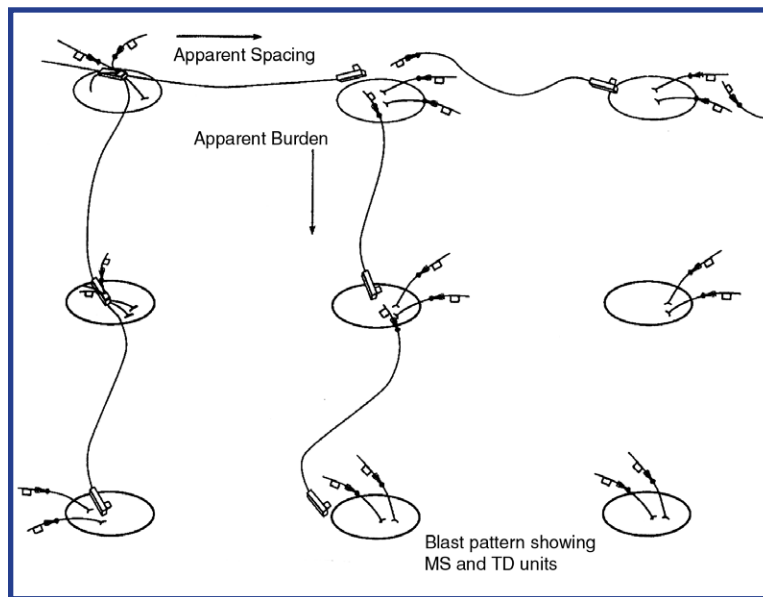

Figure 49 - Simplest form of shot layout using MS detonators down the hole and TD units on the surface.

## Use with Detonating Cord

If you plan to use TD units with detonating cord, Dyno Nobel recommends PRIMACORD detonating cords specifically designed for the initiation of shock tube through J-hook connections.

Detonating cord with coreloads less than 2.1 g/m (10 gr/ft) are NOT reliable initiators of TD units. A pigtail of 3.6 g/m (18 gr/ft) or higher coreload cord must be used to initiate outgoing shock tubes.

Know that detonating cord may tie to detonating cord and initiate through knots, but shock tube cannot. In extending a trunkline or downline, tie separate lengths of the proper cord with a square knot. Make sure the knot is tight. Also, the knot should be several inches from the cut ends of the cord to avoid parting of the knot.

### Self-to-Self Reliable Downlines

1. Make the Bunch Block connection with the detonating cord downline as detailed on page 12.
2. Snap the J-hooks of the outgoing TD unit(s) onto the detonating cord downline between the Bunch Block and the collar of the hole.
3. If you are using more than one downline, place one in the Bunch Block and tie the other to it at the collar of the hole.
4. Make sure the J-hook(s) are at least 15 cm (6 in) from the Bunch Block and 5 to 7.5 cm (2 to 3 in) from any knots.
5. Trim any excessive detonating cord tails. Extraneous contact of detonating cord and shock tube connections may result in cut-offs.
6. Once all the blastholes are connected, make a visual inspection of all hook-ups for proper connections. After verifying proper hook-up, turn each Bunch Block connection upside down and cover with drill cuttings, stemming, or other similar material to help prevent cut-offs and control noise.

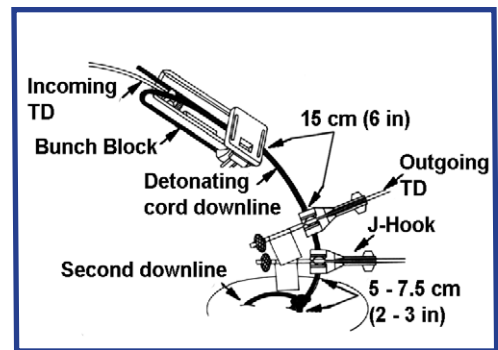

Figure 51 - Proper use of TD detonator Bunch Block with self-to-self reliable detonating cord downline(s).

**N**ever place detonating cord products and shock tube in the same Bunch Block.

**A**lways snap the J-hook to the detonating cord downline a minimum of 15 cm (6 in) from the Bunch Block, and protect the shock tube from sharpnel damage.



### Non Self-to-Self Reliable Downlines

1. Place a pigtail of 3.6 g/m (18 gr/ft) detonating cord in the Bunch Block parallel to the detonator.
2. Tie the detonating cord downlines to the pigtail with a clove hitch knot. Make sure the knots are at least 15 cm (6 in) from the Bunch Block, and that there is at least 5 to 7.5 cm (2 to 3 in) between knots.
3. Attach the J-hook(s) of the outgoing shock tube lead to the pigtail 5 to 7.5 cm (2 to 3 inches) from any knot and at least 15 cm (6 in) from the Bunch Block. Make sure all your connections are at right angles, and that the shock tube leads do not come in contact with the detonating cord after the J-hook connection.
4. Make sure the J-hook(s) are at least 15 cm (6 in) from the Bunch Block and 5 to 7.5 cm (2 to 3 in) from any knots.
5. Trim any excessive detonating cord tails. Extraneous contact of detonating cord and shock tube connections may result in cut-offs.
6. Once all the blastholes are connected, make a visual inspection of all hook-ups for proper connections. After verifying proper hook-up, turn each Bunch Block connection upside down and cover with drill cuttings, stemming, or other similar material to help prevent cut-offs and control noise.

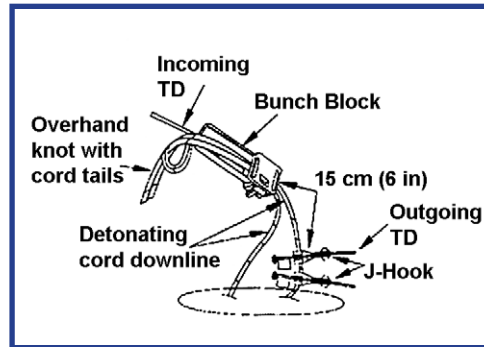

Figure 52 - Proper use of TD detonator Bunch Block with non self-to-self reliable detonating cord downline(s).

### Separate Charge Firing - Same Delay Each Hole

A blast consisting of a single charge per hole normally has the same NONEL MS detonator in every hole. In some cases, the next higher delay period may be placed at the top of the column charge. Surface delay combinations of 42ms or 25ms and 17ms TD units provide for two important functions:

1. The actual detonation time of the blasthole is greater than the surface activation time. Therefore, the risk of cut-off downlines or trunklines due to ground movement is minimized.
2. Blastholes detonate with a minimum of an 8 millisecond interval. An unlimited number of delays are available with the proper selection of surface delay times and patterns; consult your local Dyno Nobel representative.

Shock tube propagates at approximately 2000 m/s (6,500 f/s) and detonating cord propagates around 7000 m/s (23,000 f/s). Detonating cord detonates like a cap along its entire length, therefore the shock tube can be cut when the lines of connection between the initiating cord and the shock tube are not at right angles or the ties are sloppy. Cut-offs may cause misfires.

## PRIMALINE® SMS

PRIMALINE SMS detonators are initiated by a detonating cord trunkline with a coreload of at least 5 g/m (25 gr/ft). Dyno Nobel recommends its PRIMALINE 5 detonating cord for use as a trunkline, since its tacky surface ensures good contact throughout the knot connection. The detonation signal from the trunkline is transmitted to the PRIMALINE lead down the blastholes and initiates the detonator. The trunkline and PRIMALINE leads detonate at 7000 m/s (23,000 ft/s) so that, for all practical purposes, all delay elements are initiated at the same time.

**N**ever use cap-sensitive explosives, such as nitroglycerin or nitrostarch based explosives with SMS detonators.

**N**ever splice PRIMALINE leads with PRIMALINE detonating cord, such a connection will not shoot reliably.

**N**ever kink or injure the PRIMALINE leads, misfires may occur.

### Loading Procedures

1. Check the holes for obstructions with a tamping pole or loading hose of sufficient diameter.
2. Insert the SMS unit into the end of the loading hose so that the detonator points toward the collar of the hole.
3. Push the loading hose, detonator and primer to the bottom of the blast hole.
4. Withdraw the loading hose approximately 15 to 20 cm (6 to 8 in) and turn the loader on, then continue to withdraw the hose as the ANFO is loaded.

If ANFO cannot be used (due to the presence of water, for example) a non cap-sensitive primer or slip-on type booster should be used.

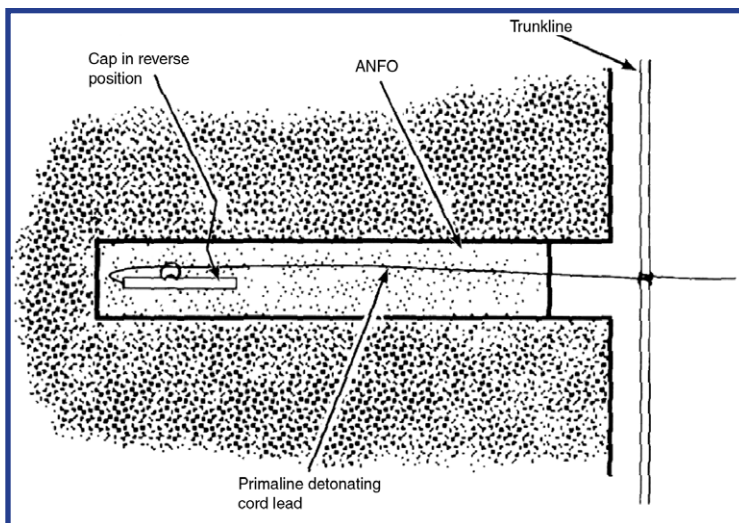

Figure 53 - Blasthole loaded with SMS detonator and ANFO.

Conventional nitroglycerin or nitro-starch based explosives MUST NOT be used with SMS units. PRIMALINE detonating cord will initiate some cap-sensitive explosives, initiating the explosive column and bypassing the delay.

Conventional nitroglycerin or nitro-starch based explosives MUST NOT be used with SMS units. PRIMALINE detonating cord will initiate some cap-sensitive explosives, initiating the explosive column and bypassing the delay.

## Hook-up to Trunklines

The PRIMALINE detonating cord lead is connected to the trunkline by a double-wrap clove hitch (Figure 54). Always keep the connections neat and square, with a minimum of slack, and trim all loose ends to prevent PRIMALINE detonating cord to trunkline crossovers, which could result in cut-offs. Always make a final inspection of the hook-up to be sure all holes are connected.

A typical Room and Pillar heading is shown in Figure 55. A trunkline of PRIMALINE 5 or PRIMACORD 5 is used to initiate the PRIMALINE leads from each blast hole. The trunkline is arranged in a closed loop with cross-ties connected at both ends

**A**lways be sure all knot connections between the PRIMALINE lead and PRIMALINE 5 trunklines are at right angles to prevent cut-offs.

**A**lways tie the PRIMALINE lead to the PRIMALINE 5 trunkline using a double-wrap clove hitch. This particular knot is necessary due to the minimum coreload in the PRIMALINE leads. Adequate surface area contact to the donor is needed for reliable initiation.

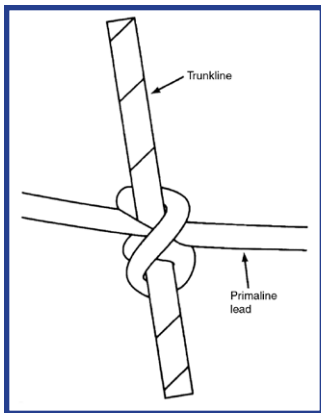
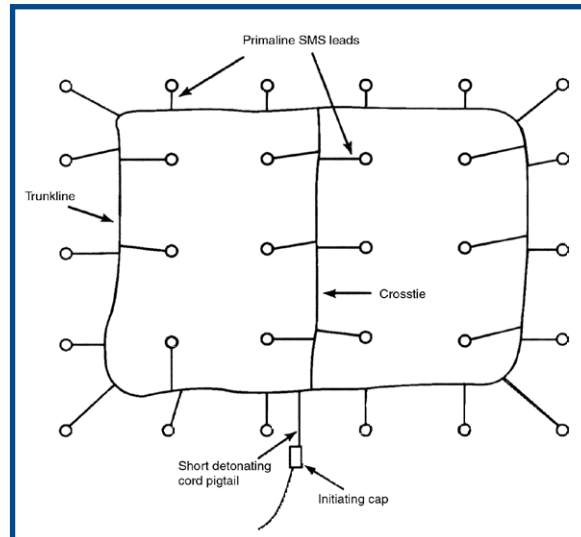

**Figure 54 - Double-wrap clove hitch; recommended knot to connect PRIMALINE SMS units to trunkline.**

**A**lways use factory-assembled units only. DO NOT attempt to field splice SMS leads or knot lengths of PRIMALINE lead together.

**A**lways use a closed loop trunkline to provide two paths of initiation to each PRIMALINE lead.

**A**lways use non cap-sensitive explosives only. The PRIMALINE lead may initiate cap-sensitive explosives, initiating the explosive column and bypassing the delay.



**Figure 55 - Typical Room and Pillar heading.**

to provide two paths of initiation to each connection.

The round is fired by attaching a NONEL Starter detonator, a cap and fuse assembly, or an electric blasting cap to a short detonating cord pigtail. This pigtail is then tied at a right angle onto the trunkline. The round is then ready to fire.

# NONEL General Application Instructions

## Primer Assemblies

NONEL products can be used with all cast boosters, dynamites and cap-sensitive explosives.

**For cast boosters**, thread the NONEL unit (of appropriate length) through the cord well of the cap primer and insert detonator fully into the cap well (Figure 56).

**A**lways be sure that the base charge of the detonator is centered in the primer.

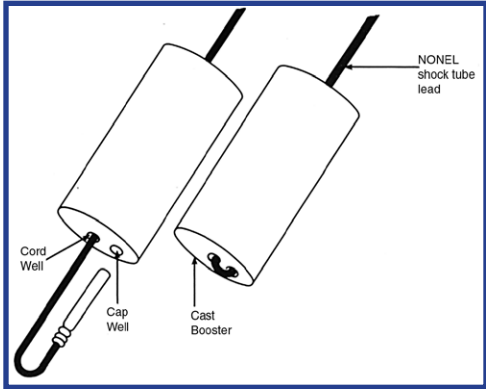

Figure 56 - NONEL / booster assembly.

**For soft package primers**, use a nonsparking powder punch to punch a hole in the primer deep enough for the entire detonator. Fully insert the detonator into the cartridge, then half-hitch or tape the lead around the cartridge (Figure 57).

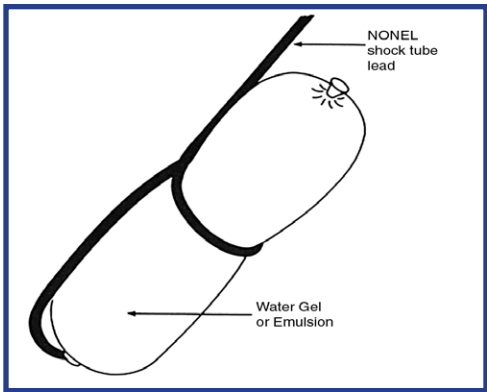

Figure 57 - NONEL assembly with water gel or emulsion.

**A**lways lower boosters into the blasthole to prevent tumbling, which could pinch shock tube between booster and borehole wall.

**For dynamite (and other paper cartridge primers)**, either tape the shock tube lead to the primer or punch a hole, using a non-sparking tool, diagonally starting at the top and exiting the side. Thread the detonator through this hole and insert fully into the cartridge (Figure 58).

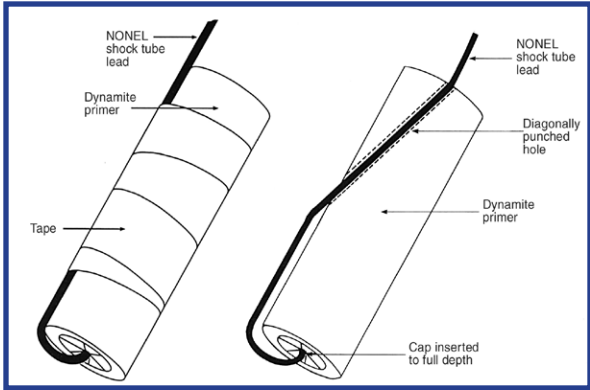

Figure 58- NONEL / dynamite primer assembly.

## Walking the Shot

Dyno Nobel strongly recommends walking the shot pattern after completion of tie-in to ensure proper path and connections. Physically check all connectors for complete insertion into the clip. This does not require the units to be picked up from the ground; if the units were properly hooked and pinned, the inspecting person can easily see them.

In situations where it will be difficult for the blaster to get back in on the shot to verify all holes have fired, Dyno Nobel recommends an additional number of surface units be tied to the last holes in the blast to help ensure all surface units have fired. Surface units with lead-in-lines may be used to get the units in a safe location for a post-blast examination.

## Initiating the Shot

1. Attach the primary initiating cap to the opening hole once all the proper connections have been made and the blast area has been cleared. Recommended primary initiating devices are (1) NONEL Starter unit, (2) an electric blasting cap, or (3) NONEL Lead Line unit with EZTL detonator.
2. Attach the primary initiator to the shock tube lead of the opening hole so it is in position to initiate the lead in both directions. (Figure 59 and Figure 61). If using NONEL Starter or Lead Line units, follow the Bunch Block connection instructions on page 11. If using an electric detonator, create a loop in the shock tube lead, and securely tape the detonator in the loop.
3. Extend the outgoing leads in a straight line for at least 30 cm (12 in) after the primary initiator has been



**Figure 59 - Shot initiation using NONEL Starter unit. Note shock tube lead position so it will be initiated in both directions.**

When using an electric detonator to fire a NONEL unit, check to make sure there are no overhead power lines present that might endanger the shot-firer. The use of two-way radios is restricted within 34 m (110 ft) of the detonator. Any unit that emits RF is restricted from use with electric detonators. Refer to IME SLP #22 for further information.

attached. NEVER bend the leads around the nose of the Bunch Block, back over the top of the connection or allow the outgoing leads to loop back near the connection (Figure 60). Any of these may result in a cut-off due to shrapnel from the exploding detonator.

4. Cover the connection with drill cuttings, stemming or other similar material to prevent cut-offs and control noise.



**Figure 60 - Incorrect hook-up; shock tube lead is bent around the nose of the Bunch Block.**

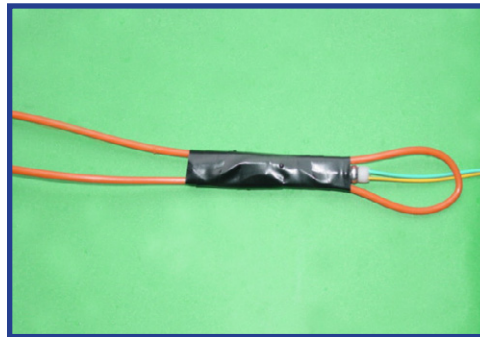

**Figure 61 (right) - Shot initiation using electric detonator. Electric detonator is securely taped to lead. Note that shock tube lead is looped, assuring initiation in both directions.**

## Detonating Cord Product Line

### PRIMACORD® detonating cord

PRIMACORD detonating cords are flexible linear explosives with a core of PETN explosive encased in a textile outer jacket. They are designed for use in various mining quarrying and construction applications.



	Coreload		Application		Tensile (min)	
	g/m	gr/ft	Downline	Trunkline	kg	lbs
<b>PRIMACORD 1</b>	1.5	7.5	X		68	150
<b>PRIMACORD 2</b>	2.13	10.0	X	X	45	100
<b>PRIMACORD 2.5</b>	2.4	12.5	X	X	27	60
<b>PRIMACORD 3</b>	3.2	15.0	X		113	250
<b>PRIMACORD 4Y</b>	3.6	18.0	X	X	68	150
<b>PRIMACORD 4R</b>	3.6	18.0	X	X	68	150
<b>PRIMACORD 5</b>	5.3	25.0	X	X	68	150
<b>PRIMACORD 8</b>	8.5	40.0	X	X	90	200
<b>PRIMACORD 10</b>	10.8	50.0	X	X	90	200

### PRIMALINE® detonating cord

PRIMALINE detonating cords are flexible linear explosives with a core of PETN explosive encased in a plastic outer jacket. They are best suited for use in abrasive mining, quarrying and construction applications.

	Coreload		Application		Tensile (min)	
	g/m	gr/ft	Downline	Trunkline	kg	lbs
<b>PRIMALINE 4D</b>	3.6	18.0		X	45	100
<b>PRIMALINE 5</b>	5.3	25.0		X	50	110
<b>PRIMALINE 21</b>	21.3	100.0	X	X	90	200
<b>PRIMALINE 31</b>	31.5	150.0	X	X	90	200
<b>PRIMALINE 42</b>	42.5	200.0	X	X	90	200
<b>PRIMALINE 85</b>	85.0	400.0	X	X	136	300

## Specialty PRIMALINE detonating cord

Specialty PRIMALINE detonating cords are PRIMALINE detonating cords designed for a specific blasting application. PRIMASHEAR® linear explosive is designed for presplitting applications, where a low velocity explosive is required to reduce radial cracking. Low Flex™ detonating cord is designed for cleaning and deslagging boilers.

	Coreload		Application		Tensile (min)	
	g/m	gr/ft	Downline	Trunkline	kg	lbs
<b>PRIMASHEAR 4</b>	3.6	18.0	X		45	100
<b>PRIMASHEAR 5</b>	5.3	25.0	X		45	100
<b>PRIMASHEAR 8</b>	8.6	40.0	X		45	100
<b>Low Flex 11</b>	11.6	55.0	X		50	110
<b>Low Flex 17</b>	17.0	80.0	X		50	110

## Trunkline

When designated as a trunkline, the purpose of detonating cord is to initiate all surface units, including NONEL MSConnector and TD units, as well as all detonating cord downlines and all in-hole NONEL detonators. All trunklines possess self-to-self reliability.

When selecting a detonating cord trunkline, consider what the trunkline must initiate and what must initiate the cord using the following guidelines:

- Detonating cords between 3.6 and 10.6 grams/meter (18 and 50 grains/foot) initiate each other and themselves through all recommended knots, unless otherwise specified. Normally cords with a coreload less than 3.6 g/m (18 gr/ft) do not initiate themselves, however, Primacord 2 (10 gr/ft), will initiate itself and other cords.
- Surface delays, such as MSConnectors, used to delay blasts initiated with detonating cord trunklines must be compatible with the detonating cord used as the trunkline.



## Downline

Detonating cord downlines are commonly used to initiate cord sensitive boosters or NONEL SL units. When selecting a detonating cord product for use as a downline, consider what explosive the cord must initiate and what must initiate the cord, using the following guidelines:

- PRIMACORD 1 and PRIMACORD 3 are initiated by all cords above 3.6 grams/meter (18 grains/foot ) but **WILL NOT** reliably initiate any of these cords or themselves; they are **NOT** self-to-self reliable.
- All boosters vary in their sensitivity to initiation from the different types of detonating cords. Practically none are sensitive to PRIMACORD 1, whereas nearly all are sensitive to PRIMACORD 10. The manufacturer of the booster will recommend the minimum coreload detonating cord for reliable initiation.

## Trunklines/Downlines

Whether selecting a detonating cord product for use as a trunkline or downline, the conditions of use must be considered in order to determine which jacket construction and coreload to use. Generally, blasthole conditions affecting the downline will determine the degree of ruggedness required. The following guidelines apply:

- PRIMACORD1, PRIMACORD 4Y, PRIMACORD 5, PRIMACORD 8, and PRIMACORD 10 all have similar jacket constructions; the inner plastic jacket is designed to resist oil and water penetration of the core. The outer textiles and wax protect this jacket from abrasion and friction, giving the cord its superior knot tying characteristics and contribute to its tensile strength.
- The larger coreload cords will generally withstand slightly more abrasion, such as that found in ragged (rough) blastholes.
- PRIMACORD 3 has a significantly more rugged jacket construction than the other low coreload detonating cords, giving it significantly higher tensile strength and abrasion resistance, but **DOES NOT** possess self-to-self reliability.
- PRIMACORD 2 and PRIMALINE 4D are lighter duty detonating cords designed for blasting conditions with little risk of abrasion damage. These cords should **NOT** be used in ragged blastholes.

# Connections & Knots

## Detonating Cord to Cord Connections

### Knots

Knots are a simple, dependable and convenient method of connection in field use of PRIMACORD and PRIMALINE detonating cords. Dyno Nobel recommends the use of the following knot connections:

- The **square knot** (Figure 62) is recommended for extending a trunkline system or splicing lengths of the same cord. The square knot should be made several inches back from the cut ends and tightened. It should only be used with self-to-self reliable cords.

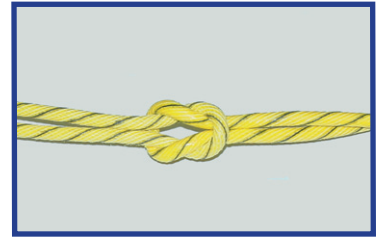

Figure 62 - Square knot.

Detonating cord downlines that are not self-to-self reliable (generally those lower than 3.6 g/m [18 gr/ft]) require the double-wrap clove hitch knot to ensure initiation.

- Either the **single-wrap clove hitch** (Figure 63) or **double-wrap clove hitch** (Figure 64) are recommended for connecting trunkline cross-ties or downlines to trunklines.

Knot connections in detonating cord should be pulled tight to create positive contact between the two lines. Detonating cord connections must be kept at right angles to prevent angle cut-off, which occurs when the downlines slant back toward the point of initiation at an acute angle (one less than 90°).

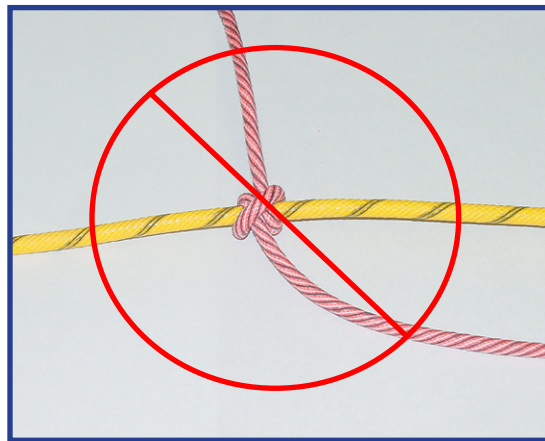

Figure 65 - Acute angle (less than 90°); cut-offs may occur.

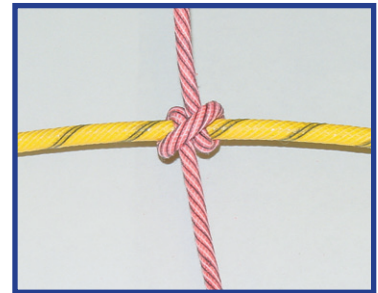

Figure 63 - Single-wrap clove hitch knot.



Figure 64 - Double-wrap clove hitch knot.

## Detonating Cord to Shock Tube Connections

### J-Hooks

The J-Hook attachment works with NONEL surface and in-hole assemblies. Connect each J-Hook to the detonating cord trunkline. Do not allow slack in the shock tube lead to cross-over the trunkline. Detonating cord detonates like a detonator along its entire length, at a velocity four (4) times faster than shock tube. If the detonating cord touches the shock tube lead, or is closer than 15 cm (6 in), other than at the J-Hook, the shock tube may be severed rather than initiated upon detonation of the trunkline. Be sure the shock tube leads are connected at right (90°) angles and that the shock tube is pulled through the J-Hook to form a tight line from the collar of the hole to the trunkline.



Figure 66 - Proper J-Hook connection.

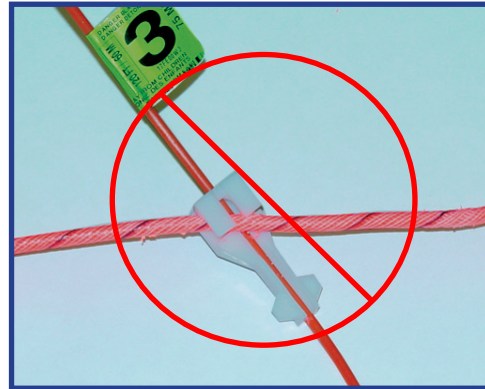

Figure 67 - Incorrect J-Hook connection; not connected at right angle. Cut-off or misfires may result.

Shock tube propagates at approximately 2000 m/s (6500 fts) and detonating cord propagates around 7000 m/s (23000 ft/s). Detonating cord detonates like a cap along its entire length, therefore shock tube can be cut when the lines of connection between the initiating cord and the shock tube are not at right (90°) angles or the ties are sloppy. Cut-offs may cause misfires.

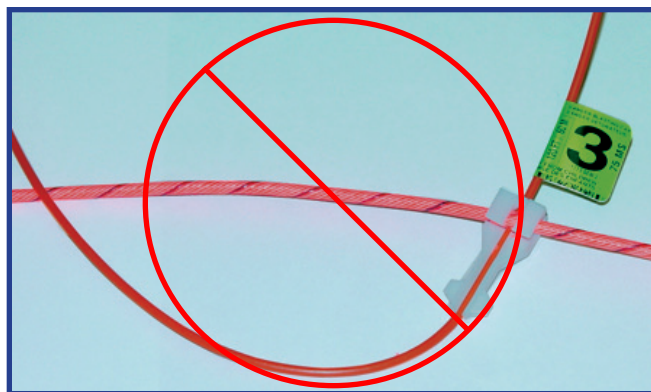

Figure 68 - Incorrect J-Hook connection; tube crosses over trunkline. Cut-off or misfires may result.

## Bunch Blasting

Bunch blasting is used when shock tube in-hole units are used with a detonating cord trunkline. When the round is loaded, gather the leads (check to be sure you have them all) in a bunch or bunches that can fit comfortably in your hand. More than 20 shock tube leads per bunch may cause a misfire in one or more shock tubes. Tie each bunch or tape each bunch once near the place where the bunch is gathered, and a second time about 30 cm (1 ft) further out. Tie the detonating cord to each bunch of shock tube leads, making a standard clove-hitch knot between the two taped sections of shock tube. The probability of a shock wave cutting off the shock tube leads, rather than initiating them, is increased if you just wrap the cord around the bunch, or tie a hangman's type of knot. This is also a problem when the ties are too close together, or when the cord is tied too close to where the shock tube spreads toward the face. When bunch blasting, always use detonating cord with a coreload of at least 5.3 grams/meter (25 grains/foot).

**N**ever place more than 20 shock tube leads in a bunch when bunch blasting. One or more the leads may not initiate, which may cause a misfire.

Dyno Nobel recommends the use of the J-Hook connection in preference to bunch blasting due to improved reliability under a full range of conditions.

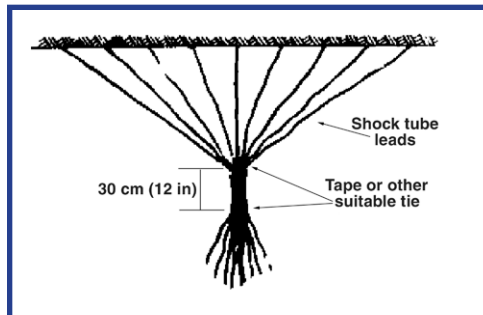

Figure 69 - Properly bunched leads.

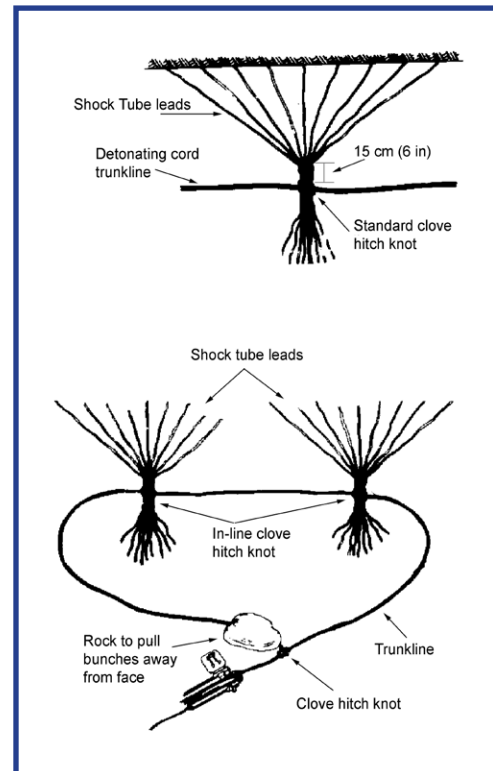

Figure 70 - Bunch blasting, properly connected trunkline.

# PRIMACORD & PRIMALINE

---

## Priming

Correct primer make-up is highly important in the successful performance of a blast. This is particularly true when assembling primers for main charges of non cap-sensitive explosives or blasting agents. Regardless of what types of explosives are used, the detonating cord should be properly and securely attached to the cartridge or booster to be loaded.

**A**lways check with the booster/explosives manufacturer for compatibility and specific procedures for using detonating cord products in your applications, including minimum coreload requirements and proper threading and tying techniques. Their recommendations should be strictly followed.

### *Cast and Slurry Boosters*

Explosives manufacturers have developed a variety of boosters designed to initiate non cap-sensitive explosives such as ANFO and other blasting agents. These boosters may be packed in flexible or rigid plastic containers; they may also be in the form of pressed or cast materials requiring no container whatsoever for loading in the borehole. Usually, these specially designed boosters are adaptable to PRIMACORD or PRIMALINE detonating cords; check with the booster manufacturer for proper initiation techniques.

## Loading Holes

It is general practice to attach the detonating cord to the first cartridge or booster loaded in the hole. For ease of deployment, a rod can be inserted through the hole in the center of the detonating cord spool. The spool can then be held by the rod, or mounted in the open top of a wooden box or other type of holder.

**A**lways construct any detonating cord spool holder from non-sparking materials.

While loading and stemming blastholes, take care to prevent damage to the detonating cord downline. If a cartridge becomes “bridged” or other difficulty is experienced in loading, and there is a chance that

the detonating cord downline has been damaged, a new booster and downline should be inserted immediately after the trouble has been corrected. The discarded downline should be kept taut and not allowed to fall into the hole where it could interfere with subsequent loading operations.

## Cutting Detonating Cord

After the primer is in position, but before loading operations continue, the detonating cord downline should be cut from the spool. Allow for sufficient length to extend above the collar of the hole to provide for the possible settling (slumping) of the load, and to make connections to trunkline(s). The end of the detonating cord downline should be secured snugly at the top to keep it fairly taut. One method is to tie it to a wooden stake or box weighed down with a stone. This will prevent the downline from being lost in the hole during loading, but still allows some movement in case the charge subsides. When not in use, the detonating cord spool should be removed from the area of the loaded hole(s).

**A**lways use a clean, sharp knife, razor blade or instrument specifically designed for cutting detonating cord.

**N**ever cut detonating cord with devices such as scissors, plier-type cutters, cap crimpers, wire cutters, or similar instruments that produce metal-to-metal contact.

## Proper Number of Downlines

One downline is usually adequate for small, medium or large diameter holes (Figure 71). However, it is recommended that two downlines be used for deep, large diameter holes loaded with multiple boosters that are separated by blasting agents or other types of non cap-sensitive explosives in the blasthole (Figure 72). Two downlines are also recom-

**A**lways cut detonating cord from its spool immediately after the charge is in place to help minimize the destructive effect of a premature detonation of the charge, which could initiate the cord attached to the charge and the entire spool of detonating cord.

**A**lways avoid situations where detonating cord or initiation system components can become entangled in machines, equipment, vehicles or moving parts thereof and prematurely initiate.

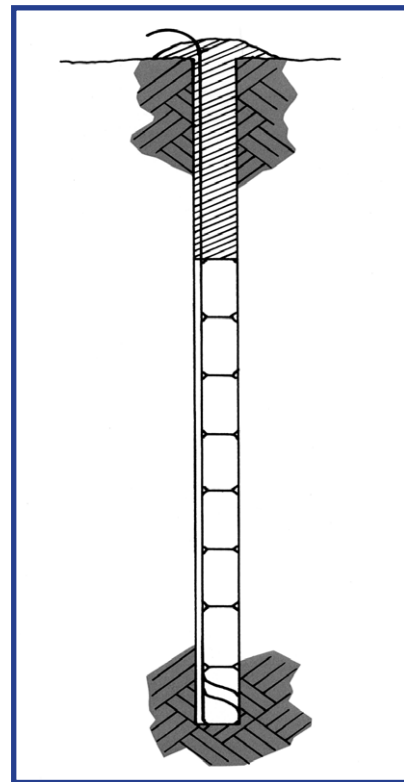

Figure 71 - A single downline attached to the first cartridge loaded.

mended when blastholes are deck loaded, i.e. when the charges are separated by inert stemming material (Figure 73).

When using multiple downlines, keep them separated in the borehole, and free of slack to help prevent cut-offs.

The purpose of the second downline is to provide positive contact with the explosives and to guard against the malfunctioning of an element in the charge. The second downline is usually introduced

with the second booster unit, just prior to deck loading; or, depending on the blast design, just before stemming the hole. When loading heavy units of blasting agents packaged in rigid fiber containers, two downlines are advisable in all cases. When using two downlines, always keep them separated in the borehole, and free of slack when making connections to the trunkline, to help prevent cut-offs.

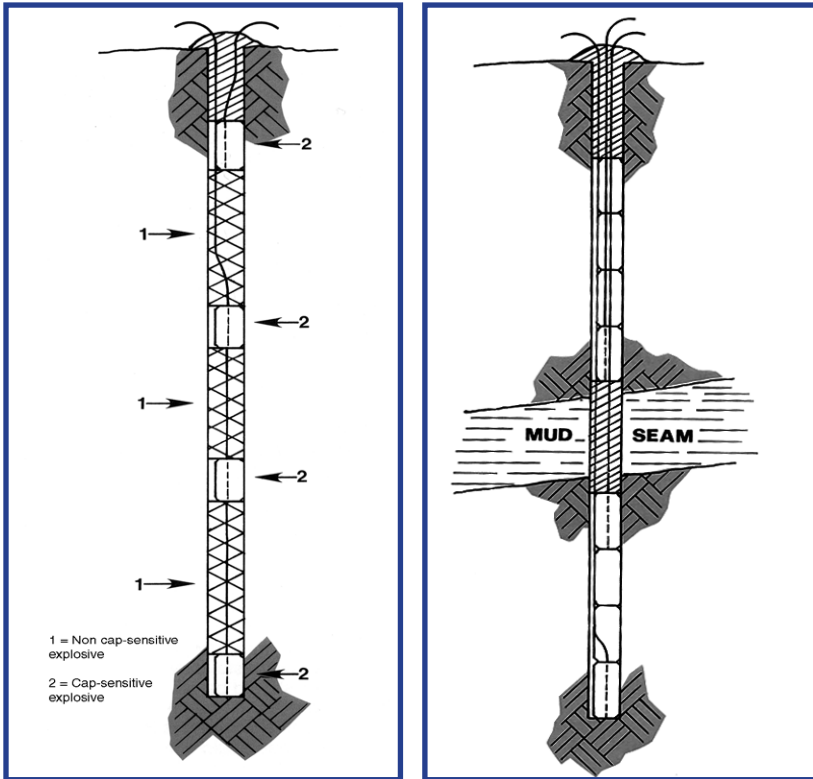

Figure 72 (right)- Two downlines in decked hole. All explosives must be cap-sensitive, otherwise each deck must include a primer.

Figure 73 (left) - Two downlines in a large diameter hole using several boosters.

## Connecting the Blastholes

After the holes have been loaded and stemmed, clear the blast site of all loading equipment, empty boxes and other extra material before starting to hook-up the blast. Allow enough time for this operation in advance of blast time so that it can proceed in a careful and orderly manner. Once the work has been started, only necessary personnel should be allowed to remain on the blast pattern. The downline-to-trunkline connections should be as close to the hole collar (stemming) as possible.

**N**ever extend a detonating cord downline in the borehole. Spools are marked with splice locations to manage this.

## Instant Firing with PRIMACORD and PRIMALINE Trunklines

Today, very few detonating cord blasts are fired instantaneously. Should instant firing be required, unreel the detonating cord trunkline so that it lies across the tops of the holes to be fired. The trunkline layout should be designed so the detonation can reach each hole from two directions; this is especially important when delay techniques are employed.

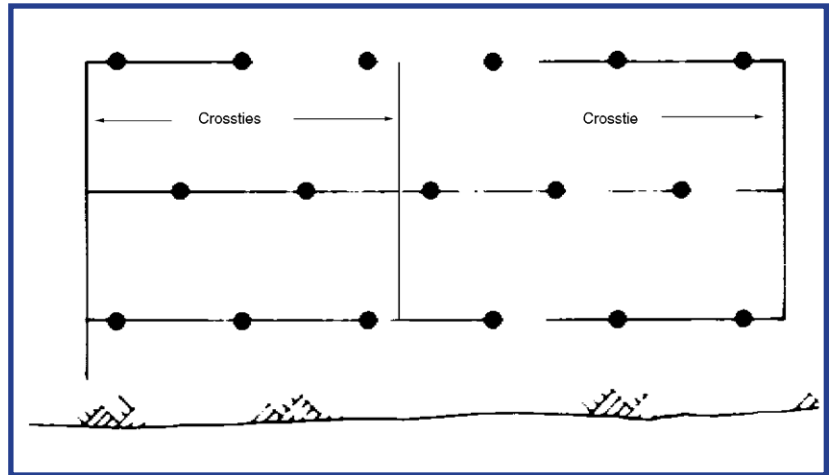

Figure 74 - Three rows of staggered holes hooked up for instant shooting using a three-trunkline system. Note the three trunkline crossties.

In multiple-row blasts, at least three sets of crossties should be provided, one at each end and one near the center of the row (Figure 74). In very long blasts, more crossties should be used. Care should be taken to see that the entire trunkline is free of loops or kinks, which could cause cut-offs. After laying out the trunkline, connect the downlines to it, using the appropriate knot connection (see page 41). Ensure the downline is at a 90° angle with the trunkline at each hole

## Delay Firing With PRIMACORD and PRIMALINE Trunklines

Short-interval delay firing techniques are those in which hole firing is delayed a fraction of a second. This method often offers several advantages over instantaneous firing, such as reduced ground vibration, noise control, improved fragmentation, and less post-blast back-break. In delay firing, it is

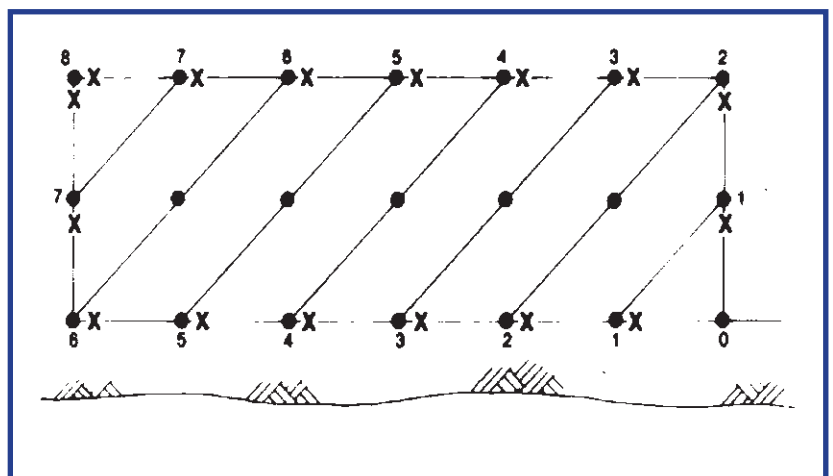

Figure 75 - Three rows hooked up with a multiple trunkline system using delays (indicated by Xs). The end hole in the row fires instantly and the subsequent holes are delayed in an echelon fashion as shown.



important to design the trunkline so detonation can reach each hole from two directions.

### *Delay Firing Without In-Hole Delays*

Though short interval-delay firing is a widely accepted practice used in surface mines, quarries and construction projects, delay blasting techniques may increase the possibility of cut-off holes or misfires, especially where no in-hole delay is used. A cut-off involves the offsetting or disturbance of the charge in a hole before the detonation of the trunkline has had time to reach the next hole or the downline has had time to reach the priming charge. Generally, this disturbance

is the result of ground movement from holes that fire earlier in the delay system. Cut-offs may involve certain hazards when using cap sensitive explosives. Hazards from cut-offs can be greatly reduced by applying the proper delay technique to suit the conditions of the blasts (Figure 78).

A **good rule of thumb**, where no in-hole delay is provided, is not to exceed one millisecond per 30 cm (1ms/ft) of spacing between holes.

The selection of the proper short interval delay arrangement is very important; especially when using delay devices located on the surface only. Hole size, burdens, spacings, type and structure of material being blasted, and general shot layout are all factors that have to be considered. A **good rule of thumb**, where no in-hole delay is provided, is not to exceed one millisecond per 30 centimeters (1 ms/ft) of spacing between holes. The surface delay should always be located closer to the hole or row being delayed, to give ground movement less opportunity to affect surface delay performance. As an example, holes spaced on 3 meter (10 ft) centers would indicate a delay of 10 ms or less. Holes with 6 meter (20 ft) spacing would indicate a delay of 20ms or less, etc.

The timing sequence for detonating cord initiated blasts may be provided by:

- detonating delays in the trunkline hook-up (MSConnector).
- nonelectric delay detonators in place of the detonating cord trunkline (TD).
- delay electric caps for initiation of downlines at the collar of each blasthole.

**N**ever introduce detonating delays into the trunkline system until just prior to blast time.

The choice of delay product for individual blasts will depend on numerous local conditions and the blaster in charge.

## **NONEL MS Connector**

NONEL MS Connector units are used in hook-ups to provide delay intervals in detonating cord trunklines. The MS Connector accepts detonation from one end, and initiates the cord at the other end at a predetermined time. The assembly is bi-directional; it will function in either direction.

When using MS Connector units it is advisable to design detonating cord trunkline systems so the detonation can reach each hole from an alternate direction in case of a break in the line. The two-way functioning of the MS Connector makes it easy to provide two paths of initiation to each row of holes through a closed-loop type of trunkline hook-up. In single row blasts involving sequence firing, a double trunkline is also recommended.

## **NONEL TD**

Occasionally, it is desirable to use detonating cord downlines in the hole, but eliminate the surface detonating cord system; this can be done by attaching NONEL TD detonators to the respective downlines at each blasthole. TD units are preassembled units whose delay elements cause the assembly to operate at the nominal firing times when the shock tube lead is properly initiated. TD detonators are designed for use as surface delays with detonating cord and/or shock tube downlines.

**A**lways snap the J-Hook to the detonating cord downline a minimum of 15 cm (6 in) from the Bunch Block, and protect the shock tube from shrapnel damage.

**N**ever place detonating cord products and shock tube in the same Bunch Block.

### *Delay Firing With In-Hole Delays*

Exposure to downline cut-offs may be further reduced by using properly selected in-hole delay detonators, such as MS or LP products. With the use of in-hole delays, the previously stated rule of thumb of 1 ms per 30 centimeters (1 ms/ft) of burden may be extended. In-hole delays provide many options for additional delay time, drastically reducing the chance of trunkline cut-off due to ground movement.

## **NONEL MS and LP**

In some applications, it may be desirable to use detonating cord as a trunkline on the surface, but to eliminate the detonating cord downline system. This can be done by using NONEL MS or LP units in the hole, and attaching the shock tube unit to the detonating cord trunkline via the J-Hook at the collar of each hole.

## **NONEL SL**

NONEL SL units are designed to provide an in-hole delay when using low-energy detonating cord downlines, such as PRIMACORD 1 and PRIMACORD 3. The detonating cord downline is connected to the SL loop using a double-wrap square knot (Figure 76).

SL units can be used in a slider configuration for decking or double priming applications. For detailed instructions, see the NONEL SL instruction section on pages 27-29 of this book.



*Figure 76 - Front (left) and back (right) views of double-wrap square knot connecting SL unit and PRIMACORD 3.*

## **Initiation of PRIMACORD and PRIMALINE**

Modern detonators are very dependable. However, two detonators are recommended at the point of initiation, especially when delay detonators are used for surface initiation of multiple hole shots. For optimal safety and reliability, detonators should be attached to a short length of detonating cord - a pigtail - that will be tied into the detonating cord system just before blast time, using a recommended knot connection. PRIMACORD and PRIMALINE detonating cords are reliably initiated with an electric detonator or NONEL Starter unit.

### *To Attach Detonator*

Be sure the loaded, or business, end of the detonator is pointed in the direction you want the detonating cord to detonate; initiation can only be assured in the direction the detonator is pointing.

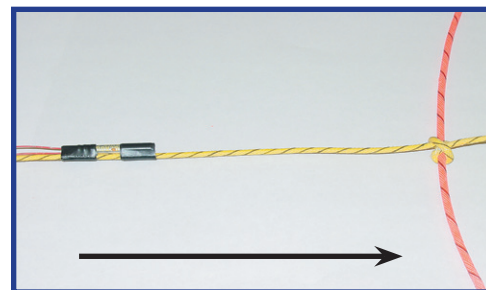

*Figure 77 - Electric detonator taped to pigtail for initiation of trunkline.*

### **If using an Electric Detonator**

1. Wrap the cord and detonator securely together with electrician's tape at the desired initiation point, at least 20 cm (8 in) from the cut end of the cord (Figure 77).
2. Tie the pigtail assembly to the detonating cord downline at the intended point of initiation using one of the recommended knot connections. Bury the detonator connection to help protect against cut-offs. If the detonating cord is wet at the point of initiation, follow the instructions for Wet Detonating Cord Initiation found below.

### If using NONEL Starter

1. Place the detonating cord pigtail in the Bunch Block parallel to the detonator, wrap the detonating cord around the bottom of the Bunch Block and then back in the Bunch Block parallel to the detonator and snap the lid firmly closed (Figure 78).
2. Tie the pigtail assembly to the detonating cord downline at the intended point of initiation using one of the recommended knot connections. Bury the detonator connection to help protect against cut-offs. If the detonating cord is wet at the point of initiation, follow the instructions for Wet Detonating Cord Initiation found below.

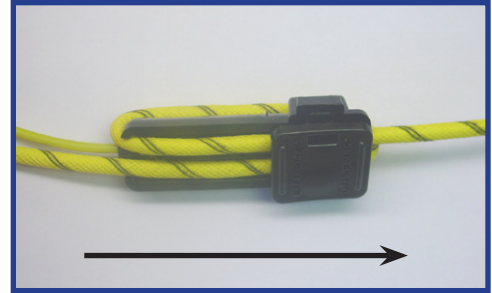

*Figure 78 - NONEL Starter detonator connected to detonating cord.*

### Initiation of Wet Detonating Cord

PRIMACORD and PRIMALINE detonating cords are much less sensitive when they are wet. Once initiated, however, straight (unknotted) lengths of these products will continue to detonate reliably, wet or dry. A detonating cord product cannot be reliably initiated through side priming if it becomes wet as a result of damage to outside jacketing, or from end penetration of water; cut ends of detonating cord sitting in water will pick up moisture through capillary action. Knot connections of wet PRIMACORD or PRIMALINE products also compromise initiation. For any spool of cord that has been in storage, cut a few inches from the cord to ensure a dry train of explosives. The only recommended methods of wet end initiation are:

- 1) end priming with a #8 strength (or higher) detonator.
- 2) use of a high velocity booster, such as a cast booster or 80% gelatin dynamite.

### End Priming

1. Squarely cut the wet detonating cord.
2. Be sure the business end of the detonator is squarely against the exposed PETN core.
3. Tape the detonator and detonating cord securely together (Figure 79).



*Figure 79 - End priming. The detonator is securely taped to the end of the detonating cord.*

## Booster-Type Connections

Booster-type connections are normally used for preloaded (sleeper) charges, where the end of the detonating cord downline would be exposed to water for an extended period of time. To make a booster-type connection:

1. Place the downline and trunkline through the booster. The trunkline initiates the booster, which, in turn, initiates the wet downline.
2. If holes will stand loaded for a long period of time, the visible end of the downline should be supported well off the ground on a stake or box, where it cannot be submerged in standing water.

### *Using PRIMACORD & PRIMALINE with Bulk Explosives*

Bulk explosives, such as ANFO (ammonium nitrate and fuel oil), emulsions, emulsion blends, and slurry products, are widely used commercial blasting agents. The effect of oil contamination on the PETN core of detonating cord products due to prolonged exposure to bulk explosives is essentially the same as that of water. Side initiation using a blasting cap, knots and other connections must be made at points that are, and will stay, dry. The previously described end priming and booster type connections must be used if the explosive (PETN) core is contaminated with oil. Once initiated, straight (unknotted) lengths of PRIMACORD or PRIMALINE detonating cord will continue to detonate dependably even if the explosive core is contaminated.

**N**ever drop surplus detonators or detonating cord down boreholes in blasting service or other applications, except in situations where the ends of the cord are cut from either the in-hole line or the surface cord. These small pieces should never be longer than one-half the borehole diameter and should be dropped into the borehole and followed by a bulk product (i.e. ANFO) or bulk blend. Keep in mind that these cord fragments actually add energy to the borehole.

## **Product Troubleshooting**

---

The Product Troubleshooting class was designed with the customer and technical sales personnel in mind to provide training in identifying the results of product application errors, and to develop a basic understanding of the technology behind the ISVS products. With a hands-on approach focused on reviewing proper product deployment/connection, and close visual inspection of the results of incorrect product hook-up, the customers and sales personnel learn to spot characteristics that can help identify common application errors. In addition, the attendees increase their overall knowledge of initiation systems products.

The information presented here is intended as a reference only. To arrange a Dyno Nobel Product Troubleshooting course at your site, please contact your local Dyno Nobel representative.

## NONEL EZ DET - Shot Initiation

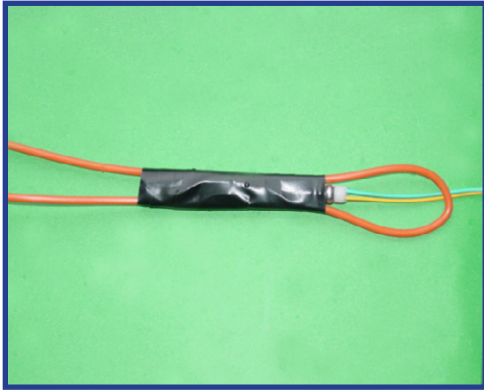

*Figure 80 - Initiation with an electric detonator.*



*Figure 81 - Initiation using a Bunch Block.*

**A**lways attach the Starter cap to the EZ DET lead at the opening hole so it is in position to initiate the EZ DET shock tube leads in both directions.

## Connection Inspection

---

Double check all connections before moving on to the next hole. Once all holes are connected, do a final inspection after all holes are connected by walking the shot looking for:

- Correct connection of all holes and shock tubes
- All tubes fully in the block
- Connecting tubes are neat but not tight and run at right angles to the connection and do not loop back.

When the inspection is complete, secure the blast area and ensure the connections are not disturbed. Perform the connection inspection again if the shot sits unfired for any length of time or if there is any possibility the connections may have been disturbed.

**A**lways make a CONNECTION INSPECTION after each hook-up.

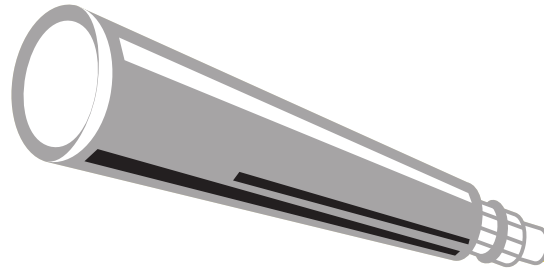

# NONEL

**Grip It!**  
**Clip It!**  
**Slide It!**  
**Shoot It!**





## **NONEL EZ DET & EZTL - Connection**

- Be sure the shock tube(s) is properly inserted into the connector block.
- A surface connector can accommodate 1 to 6 shock tubes.
- Insert one shock tube at a time to prevent improper connections in the connector block. Slide the connector to the collar of the hole.
- **Grip it, Clip it, Slide it, Shoot it.**

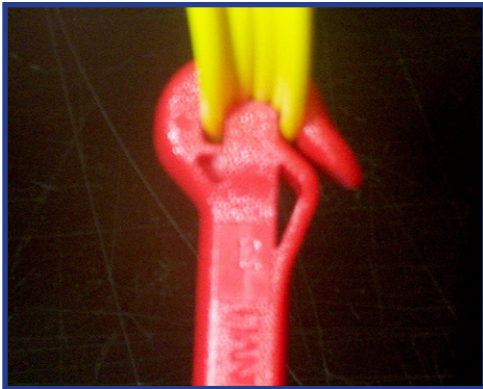

*Figure 82 - All six shock tubes in the correct position.*

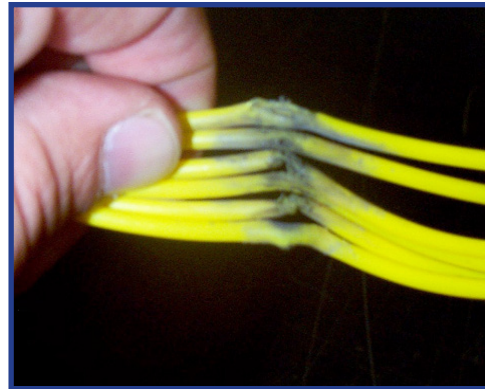

*Figure 83 - Good "hit" marks on shock tube properly positioned in connector block.*

## **NONEL EZ DET & EZTL - Connection**

- Be sure the shock tube(s) is properly inserted into the connector block.
- After inserting the shock tube(s) securely into the surface connector, slide the surface connector. This will help orientate the shock tube into the block.
- **Grip it, Clip it, Slide it, Shoot it.**

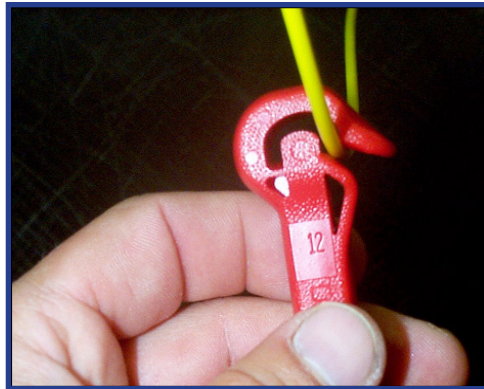

*Figure 84 - Shock tube not fully inserted in connector block.*

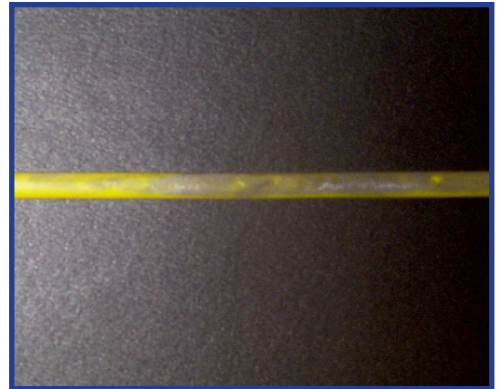

*Figure 85 - Shock tube after functioning the EZ DET at left; the tube shows carbon/Al residue with no penetration marks into the jacket of the shock tube.*

## NONEL EZ DET & EZTL - Connection

- Be sure the shock tube(s) is properly inserted into the connector block. Insert one shock tube at a time to prevent crossovers in the connector block.
- After inserting the shock tube(s) securely into the surface connector, slide the surface connector. This will help orientate the shock tube into the block correctly.
- **Grip it, Clip it, Slide it, Shoot it.**



*Figure 86 - Shock tube crossed over in the connector block.*

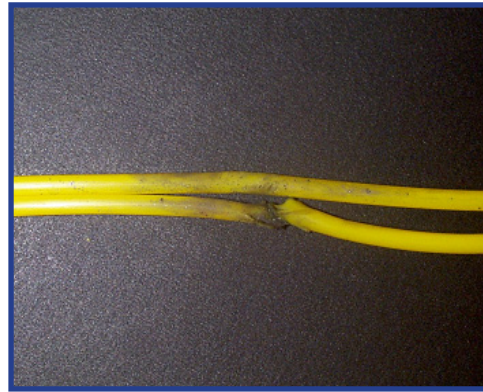

*Figure 87 - Shock tube after functioning the EZ DET at left; one shock tube has a small carbon/Al mark and the shock tube that was located closer to the cap is twisted and received a good "Hit Mark."*

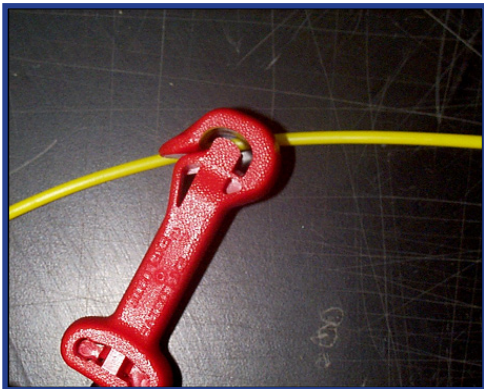

*Figure 88 - Shock tube not clipped in at all.*

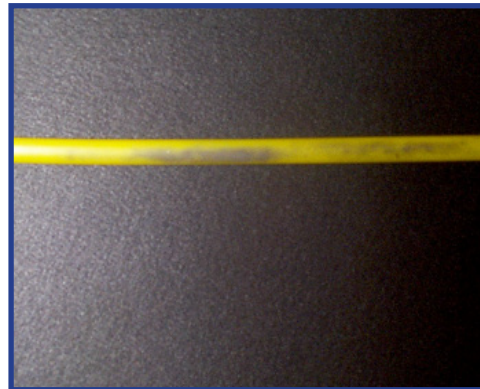
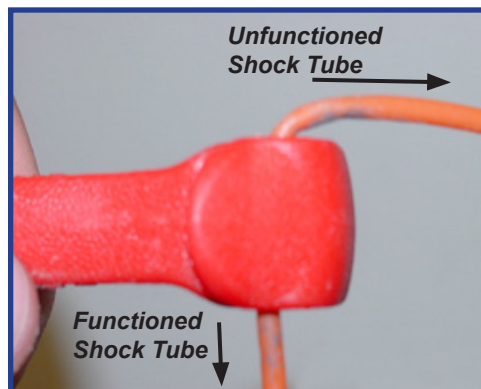

*Figure 89 - "Hit Marks" left on shock tube that is not clipped in but is under the connector block.*

## NONEL EZ DET & EZTL - *Matting*

- If a shot is to be covered with blasting mats and/or backfill material.
- Cover the surface connectors with a least 15 cm (6 inches) of gravel or drill cuttings.
- Avoid any sharp kinks under the backfill or matting material.

**A**lways backfill or mat carefully to avoid any damage to the surface connections and shock tube.

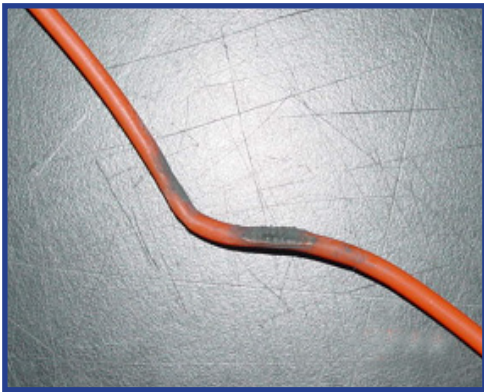

*Figure 90 - Tube bent by backfilling or matting. Block shown was NOT used to fire the shock tube shown.*

## NONEL EZ DET & EZTL - Matting

- Hit mark appears normal with penetration into the sub tube.
- The shock tube functioned in the direction of the unbent end.
- The hit mark looked good.

**Note:** Velocity profiles of NONEL shock tube shows that it can take up to 20cm (8 in) to reach the steady state VOD.



*Figure 91 - Note the permanent bend in the shock tube.*

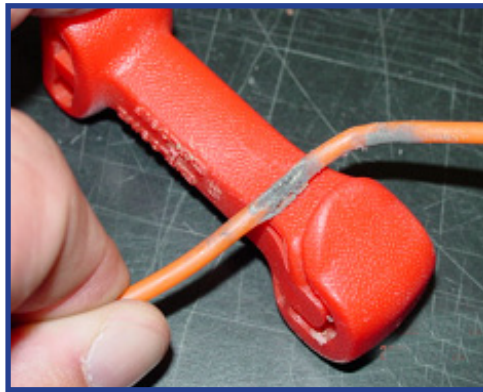

*Figure 92 - The carbon under the permanent bend shows that the tube was bent during the functioning of the cap.*

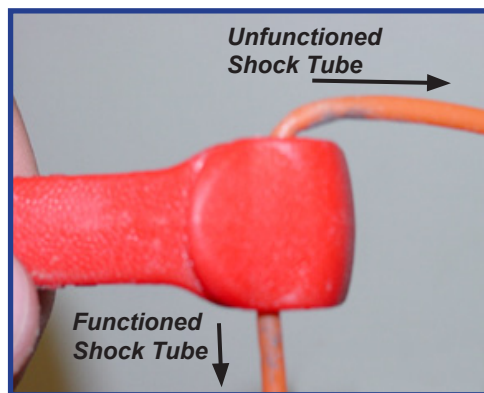

*Figure 93 - Shock tube bent by backfilling or matting. Block shown was NOT used to fire tube shown.*

## Connector Block Confinement

- Connector Block Deformation is NOT an accurate indicator of detonator output/energy yield.
- Deformation is related to, but not the biggest influence on, output/energy yield.

**Note:** The biggest influence on deformation and appearance of EZ Connector blocks after functioning is confinement.



*Figure 94 (above)  
No Confinement; Open  
Air Function*

*Figure 95 (right) Com-  
plete Confinement;  
Head in sand*

*Figure 96 (above) Top  
Confinement; Top  
against metal plate.*

*Figure 97 (left)  
Partial Confinement;  
Flat in sand*

## NONEL TD - Connection

- Place all down lines and out-going trunkline leads in the Bunch Block in the desired direction of initiation and tails behind the Bunch Block.
- Make sure all outgoing leads are properly positioned and leave the Bunch Block in a straight line. Any of these may result in a cut-off due to shrapnel from the exploding Bunch Block.
- Make sure all J-Hooks are at least 15 cm (6 in) from the Bunch Block and 5 - 7 cm (2 - 3 in) from any knots.
- NONEL TD will initiate up to 8 properly connected shock tube leads or one detonating cord lead.

**A**lways cover Bunch Block with drill cuttings, stemming or other similar material.

**N**ever bend the tube around the nose of the Bunch Block, back over the top of the Bunch Block, or allow the outgoing trunklines to loop back near the Bunch Block.

**N**ever place detonating cord and shock tube in the same Bunch Block.

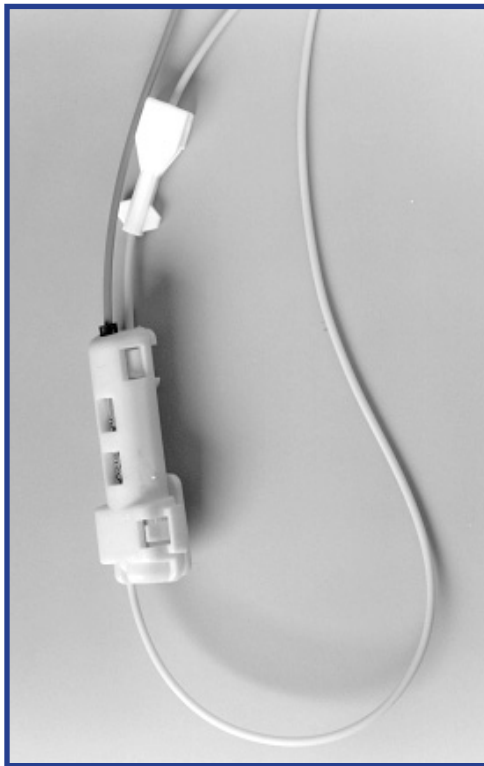

**Figure 98 - The shock tube should not loop back near the Bunch Block.**

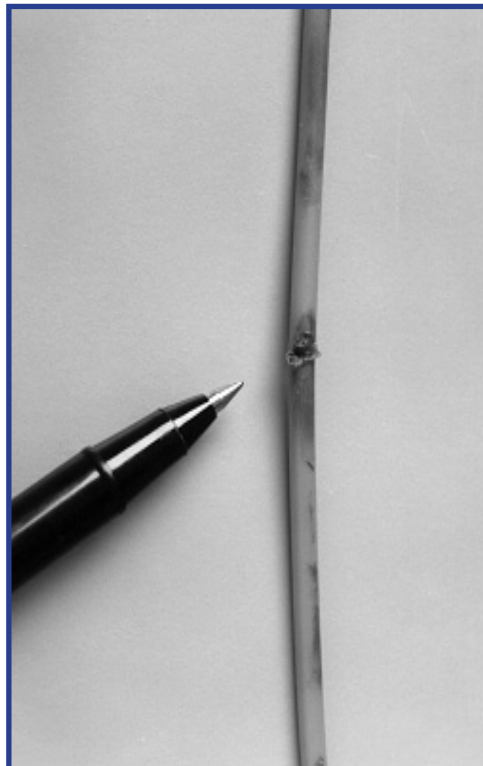
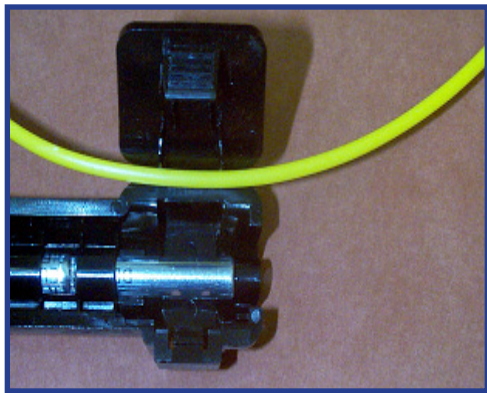

**Figure 99 - Shrapnel damage from looping shock tube too close to Bunch Block.**

## NONEL TD - Connection

- When snapping the lid of the Bunch Block closed, Make sure all outgoing leads are properly positioned and leave the block in a straight line for at least 30 cm (1 ft).

**A**lways make sure the lid is closed tightly and that shock tube is not pinched under the lid.



**Figure 100 - Shock tube incorrectly placed in Bunch Block.**



**Figure 102 - Shock tube on the left failed to initiate because it was positioned between the Bunch Block lid and hinge. (unit returned from customer)**



**Figure 101 - Shock tube shut in Bunch Block hinge. Misfire may occur.**

**Shock tube on the right also failed to initiate because it was positioned between the Bunch Block lid and hinge. This position creates a pinch point that will shut down the shock tube. (created in the laboratory)**



## NONEL TD, LP and MS - Shock Tube to Detonating Cord

- Make sure all outgoing leads are properly positioned and leave the J-Hook in a straight line.

Shock tube propagates at approximately 2,000 m/s (6,500 ft/s) and detonating cord propagates around 7,000 m/s (23,000 ft/s). Detonating cord detonates like

a cap along its entire length, therefore shock tube downlines can be cut when the line of connection between the initiation cord and the shock tube are not at right angles or the ties are sloppy. Cut-offs may cause misfires.

**N**ever bend the shock tube around and contact the detonating cord. This will result in a shock tube cut-off.

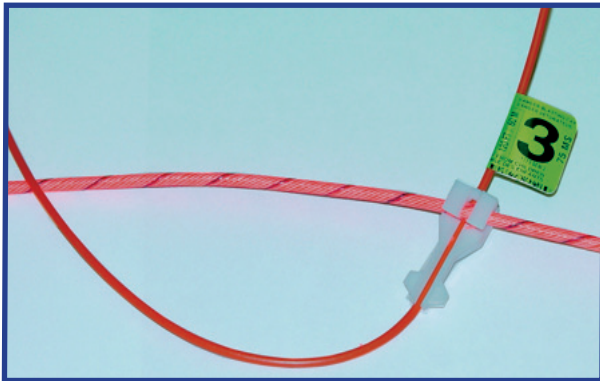

Figure 103 - Shock tube should never contact cord except at the initiation point.



Figure 104 - Left shock tube damaged by detonating cord as shown in Figure 111. Right shock tube damage is due to extended linear contact with detonating cord.

## **NONEL TD, LP and MS - J-Hook: Shock Tube to Detonating Cord**

- Make sure all outgoing leads are properly positioned and leave the J-Hook in a straight line.

Shock tube propagates at approximately 2,000 m/s (6,500 ft/s) and detonating cord propagates around 7,000 m/s (23,000 ft/s). Detonating cord detonates like a cap along its entire length, therefore shock tube downlines can be cut when the line of connection between the initiation cord and the shock tube are not at right angles or the ties are sloppy. Cut-offs may cause misfires.



*Figure 105 - Shock tube should leave J-Hook in a straight line. The above image shows an "Angle Cut-off".*



*Figure 106 - Shock tube damaged by detonating cord*

## **NONEL TD, LP and MS - J-Hook: Shock Tube to Detonating Cord**

- Make sure all outgoing leads are properly positioned with the J-Hook securely clipped onto the detonating cord trunkline.



**Figure 107 - J-Hook improperly connected to the trunkline**



**Figure 108 - Result of the hook-up at left; can result in an initiation failure**

## **NONEL SL - Knot Connection**

- Attach detonating cord to the loop of the NONEL SL nonelectric delay detonator with a double-wrap square knot.



*Figure 109 - Good knot.*

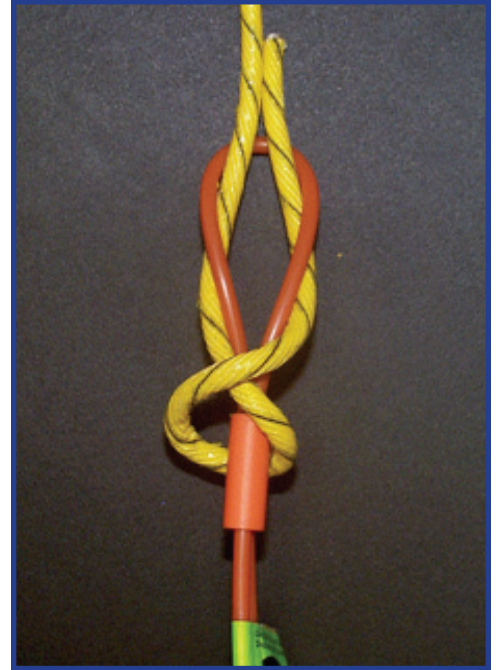

*Figure 110 - Bad knot, not tight.*

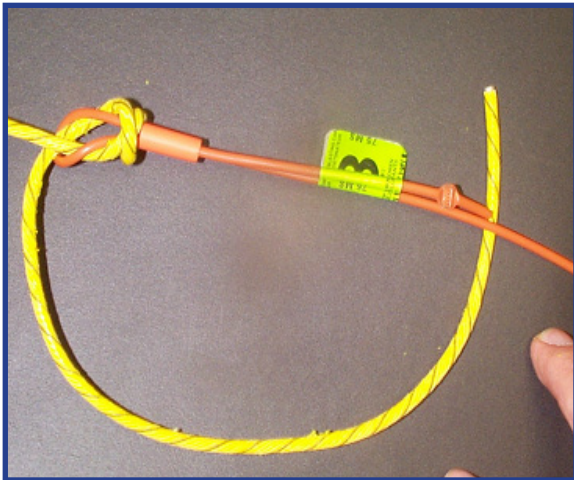

*Figure 111 - Result of bad knot.*

## **NONEL SL - Knot Connection**

- Attach detonating cord to the loop of the NONEL SL detonator with a double-wrap square knot.
- Trim excess detonating cord from double wrap square knot.

**N**ever let the detonating cord wrap around and contact the shock tube. This may result in a shock tube cut-off.



*Figure 112 - Detonating cord tail is too long, shock tube cut-off likely.*



*Figure 113 - Shock tube damaged by cord tail. The shock tube can also be severed.*

## **NONEL MS Connector - Connection**

- Place the detonating cord in the groove of the connector block, with about 23 cm (9 in) of detonating cord tail protruding out the same end of the connector block as the shock tube.
- Wrap the tail of the detonating cord around the end of the connector block cleat so that the detonating cord snaps into the securing feature of the block, locking the cord in place.
- Cut the tail of the detonating cord so that it does not come in contact with the shock tube.

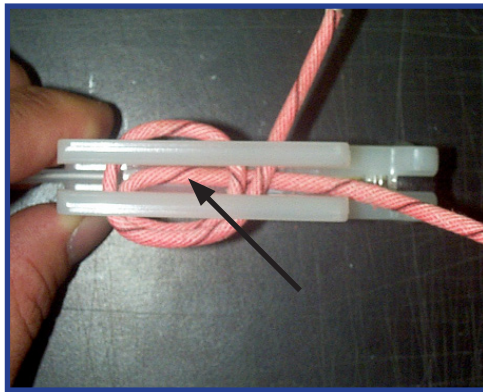

**Figure 114 - Detonating cord correctly wrapped and in groove of MS Connector.**

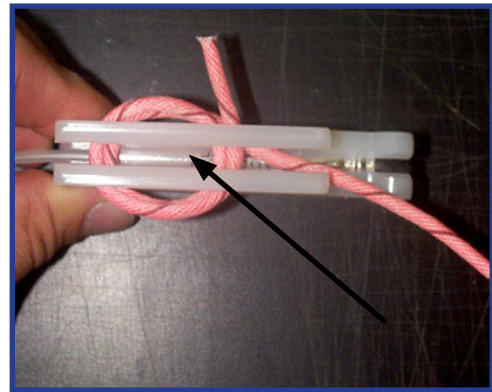

**Figure 115 - Detonating cord not in groove.**

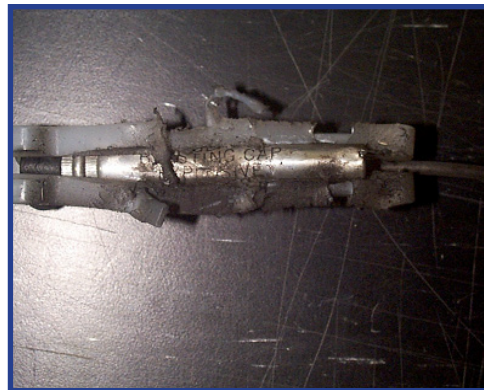
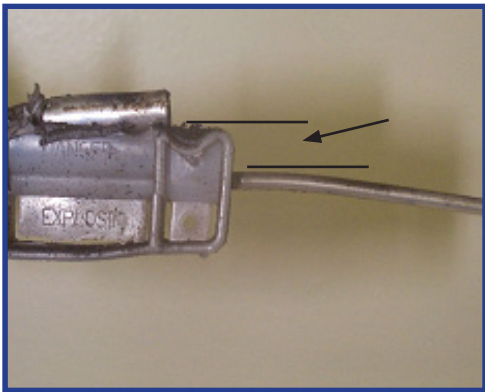

**Figure 116 - When the detonating cord is not in the groove of the connector it may not initiate the detonator base charge.**

## **NONEL MS Connector - *Cord Not in Groove***

- Detonator suspected not to have had detonating cord in groove of the connector. After the detonating cord functioned, a gap was created between the shock tube and the detonator. The delay was initiated - not the base charge - and functioned the detonator after this gap was created.

**A**lways place the detonating cord in the groove of the connector block.



**Figure 117 - Gap between detonator and shock tube.**

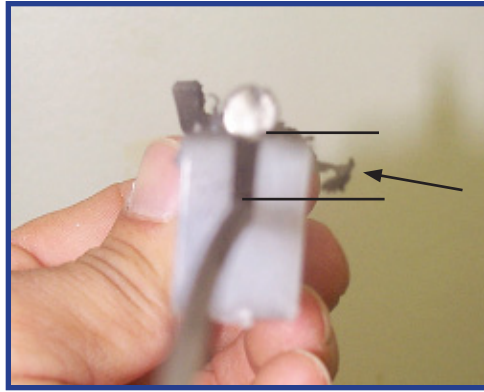

**Figure 118 - Gap between detonator and shock tube.**



**Figure 119 - Detonator after functioning with detonating cord NOT in groove of the connector.**



**Figure 120 - Detonator after functioning with detonating cord in groove of the connector.**

## **NONEL MS Connector - *Detonating Cord Tail Damage***

- Cut the tail of the detonating cord so that it does not come in contact with the shock tube.

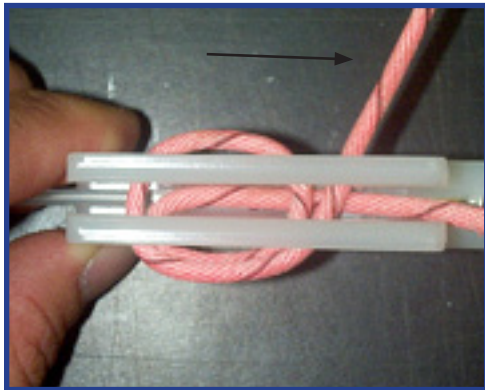

**Figure 121 - Detonating cord tail should be cut after connection is complete.**

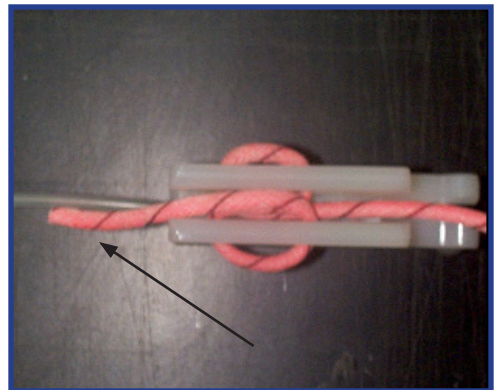

**Figure 122 - Make certain that the detonating cord does not come in contact with or come near the shock tube lead.**



**Figures 123 & 124 - Failures may result if shock tube contacts cord.**



## Detonating Cord Cut-off

- All detonating cord connections must be pulled tight, so that the two lines will be in positive contact. Also, it is important to keep right angles at each detonating cord connection.
- “Angle” cut-off failures are caused by the explosive force (or fragment) of the detonating cord severing the receptor cord before the detonation wave has initiated the receptor cord at the point of connection.
- Make sure all detonating cord lines are not looped or kinked. Avoid crossing over detonating cord. If a detonating cord does not have adequate surface area contact it may sever the other cord not initiate it.

**A**lways make sure there are no loops or kinks in any detonating cord lines to avoid cut-offs. Cut-offs may cause misfires.

**A**lways make shock tube and detonating cord connections at right angles to avoid the possibility of cut-offs. Cut-offs may cause misfires.



*Figure 125 - Center cord was returned by a customer and shows the typical signs associated with an “Angle” or “Cross Talk” cut-off.*

*Right and left samples were manufactured with a void in the explosive core to create an in-line failure. This test was designed to show the physical differences between an in-line failure and cord cut-off.*

## Shock Tube Abrasion

- The shock tube has function completely to the damaged section of shock tube.

**A**lways put the “V” cut in your new underground loading hose! This will help prevent the abrasion of the shock tube lead.

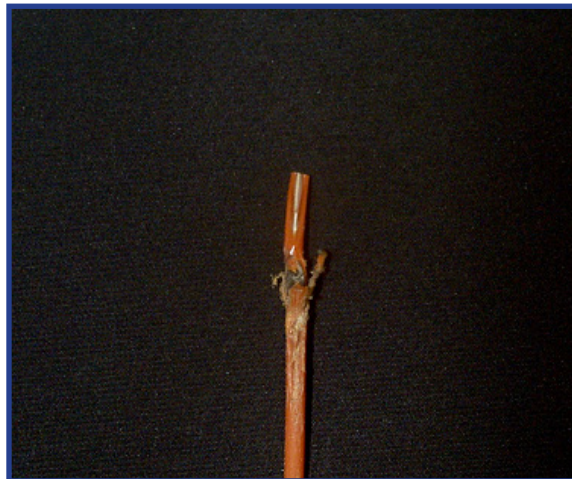

*Figure 126 - The cap (removed from this unit) did not function because of the damage shown, which occurred during loading.*

## Pinch-Smash Breaks

- Pinch-Smash breaks occur when deploying the boosters; the shock tube breaks when it is pinched between the booster and the borehole wall.

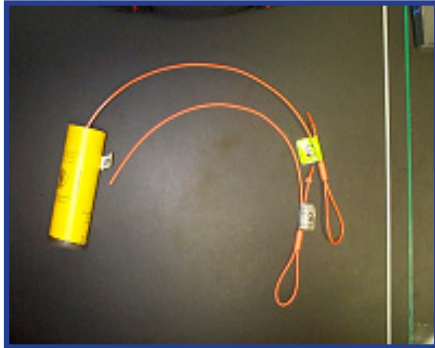

Figure 127 - Bottom tube was broken by pinching between borehole wall and booster.

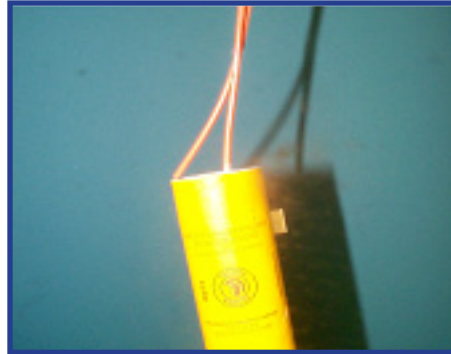
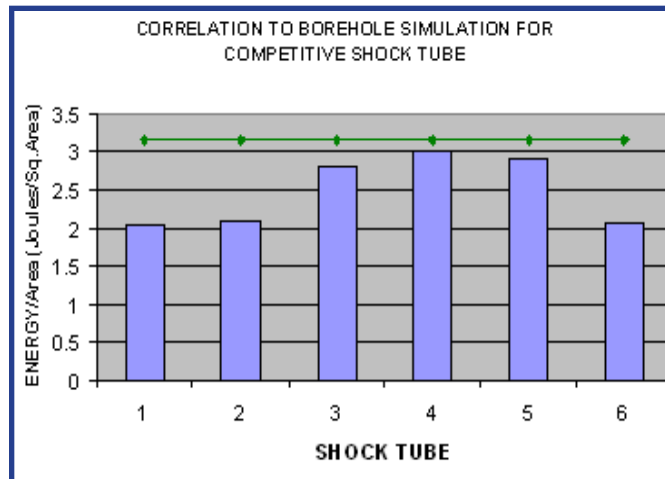

Figure 128 - Shock tube position that may result in a pinch smash break.



Figure 129 & 130 - Shock tube that has been cut by a pinch-smash break.

Figure 131 (right) - Shows a green line at 3.15 joules/cm<sup>2</sup>. This is the energy that will result in the impact of a booster dropped from ten feet on shock tube at a 45-degree angle. If impacted correctly all shock tube currently available will have some amount of "Pinch smash breaks". Bars represent six of the different shock tubes available in the market today.



## Pinch-Smash Breaks - *Lower, Don't Drop*

- Pinch-Smash breaks occur when deploying the boosters; the shock tube breaks when it is pinched between the booster and the borehole wall.

**A**lways center the primer assembly over the borehole and ease the assembly down the borehole to help prevent shock tube breaks.



*Figure 132 - Primer assemblies awaiting loading.*



*Figure 133 - Any booster tumbling in borehole is likely to break these shock tube leads.*

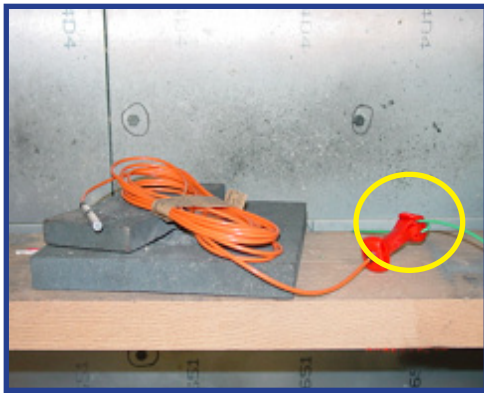

*Figure 134 - Primer assembly with shock tube lead broken due to pinch smash.*

## Reverse Propagation Testing

- NONEL EZ DET did not reverse propagate, whereas some competitor's product will.
- Testing conducted using 0.9 g/m (4 gr/ft) detonating cord.

**N**ever use EZTL or EZ DET products with detonating cord. Misfires may result.



*Figure 135 - NONEL EZ DET set up for test. Note green 0.9 g/m detonating cord inserted in connector block (circled).*

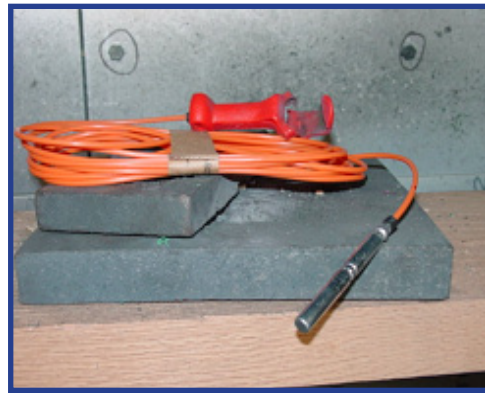

*Figure 136 - NONEL EZ DET after test. Unit did not reverse propagate.*

## Detonating Cord - *Connection Inspection*

- Photo shows underground hook-up where two J-Hooks are incorrectly hooked up to the detonating cord trunkline.
- Walk the shot after before firing the blast to ensure all connections are made.

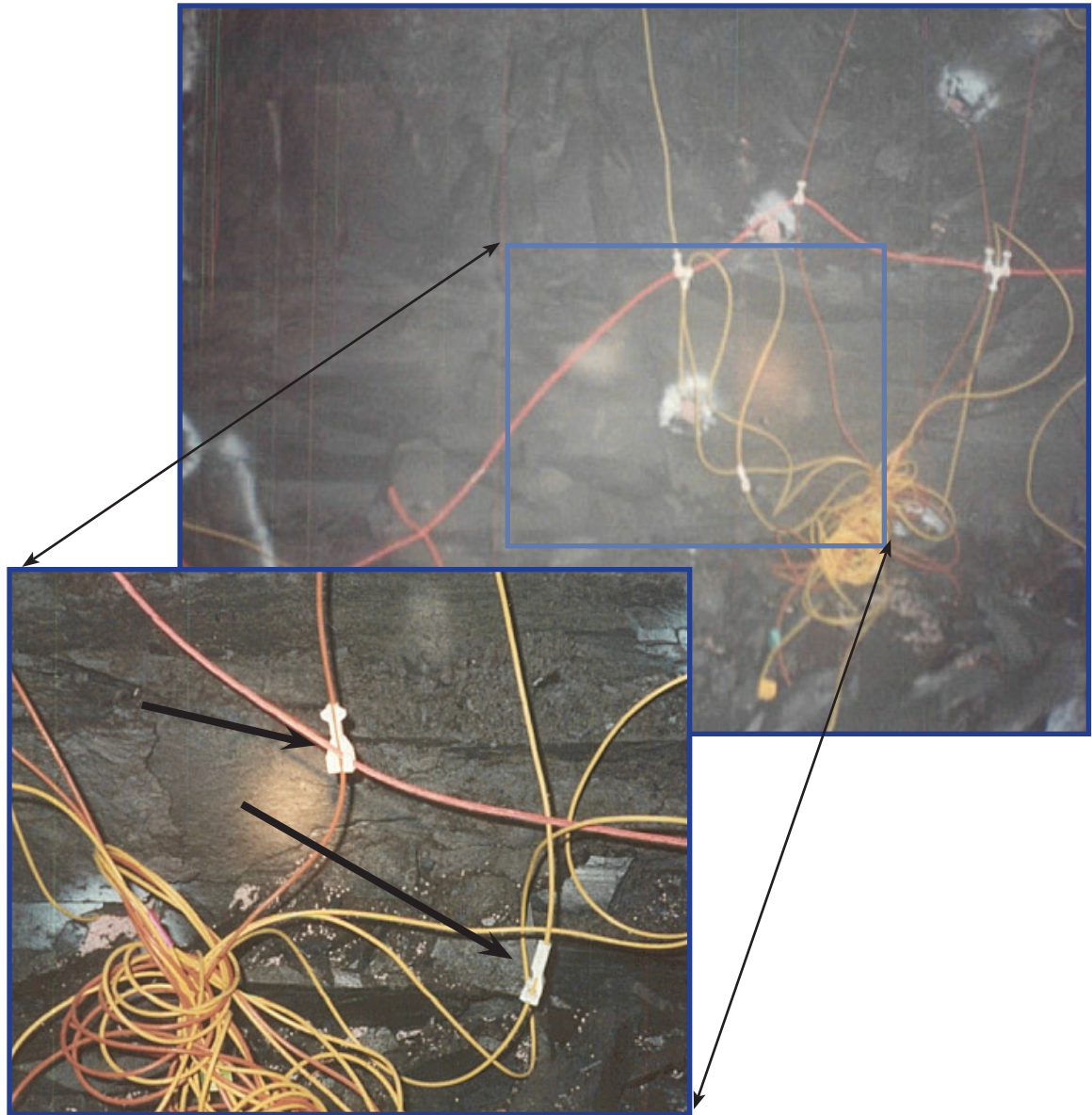

**Figure 137 - Top arrow points to J-Hook only partially connected to trunkline.**

**Bottom arrow points to J-Hook not connected to trunkline at all.**

## Check Tubes - *Connection Inspection*

- Walk the shot after before firing the blast to ensure all connections are made.

**A**lways walk your shot before initiation.

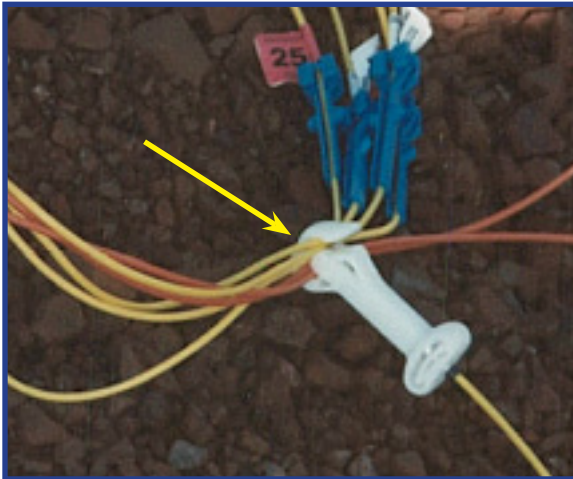

*Figure 138 - Tubes out of connector block.*



*Figure 139 - Tube partially out of connector block.*



*Figure 140 - Tube has been chewed.*

## Lead Line - *Powder Migration Prevention*

- If a NONEL Lead Line spool is in a spool holder with shock tube windings oriented vertically, powder migration may occur. This may produce shock tube blow outs if the shock tube is held in this orientation and transported over mining roads for a length of time.

**A**lways transport NONEL Lead Line positioned upright and sitting on the hub face, NOT on its side on the edges of the spool hub, to help prevent powder migration, which may result in shock tube blow outs.



**Figure 141 - Correct orientation for transportation.**



**Figure 142 - Incorrect orientation for transportation. Powder migration may occur.**





**Dyno Nobel**  
**2795 East Cottonwood Parkway**  
**Suite 500**  
**Salt Lake City, UT 84121**  
**(801) 364-4800**

**DYNO**  
**Dyno Nobel**

**G r o u n d b r e a k i n g P e r f o r m a n c e**